

AMERICAN LEATHER PRODUCT CATALOG

COMFORT SLEEPER®

AMERICAN
LEATHER®

COMFORT SLEEPER® BY AMERICAN LEATHER®

BRANDT



**AMERICAN
LEATHER®**

Standard Comfort Sleeper®

Features:

- Featuring the patented Tiffany 24/7™ platform sleep system
- Room to stretch out with true 80 inches of bedroom-length sleeping surface
- Ultimate comfort on four inches of plush, high-density foam mattress
- Zero wall clearance
- Quick-ship delivery
- Single-needle top-stitch
- High-density, high-resiliency foam seat cushions
- Loose back and seat cushions
- Lifetime warranty on frame
- 10-year mechanism warranty
- Brushed stainless steel sled leg

Mattress Options:

- Premier with Crypton® ticking
- Gel
- Tempur-Pedic®

Options:

- High-density, high-resiliency foam seat cushions encased in down and down back cushions available

Please use actual leather, fabric, Crypton®, Sunbrella® and Ultrasuede® swatches when specifying furniture as the colors shown may vary due to the printing process.

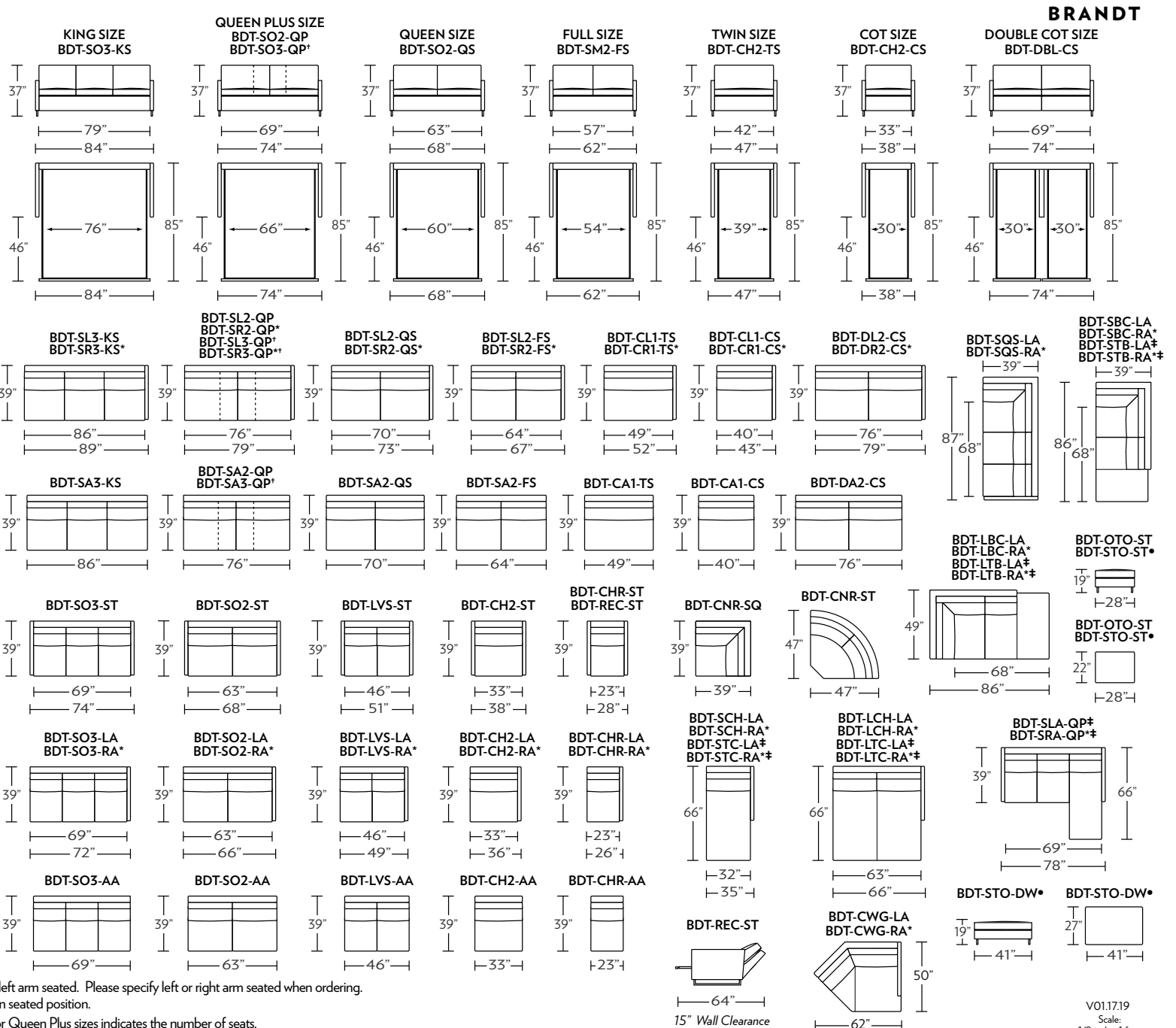
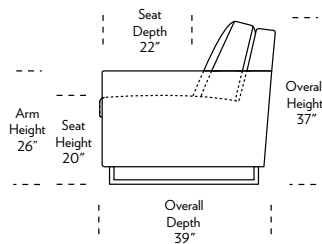

* Picture shows left arm seated. Please specify left or right arm seated when ordering.
 † All orders are in seated position.
 ‡ Dotted lines for Queen Plus sizes indicates the number of seats.
 All dimensions are approximate and subject to change.
 * Chaise lifts up to reveal hidden storage space. • Storage

COMFORT SLEEPER® BY AMERICAN LEATHER®

BRYSON

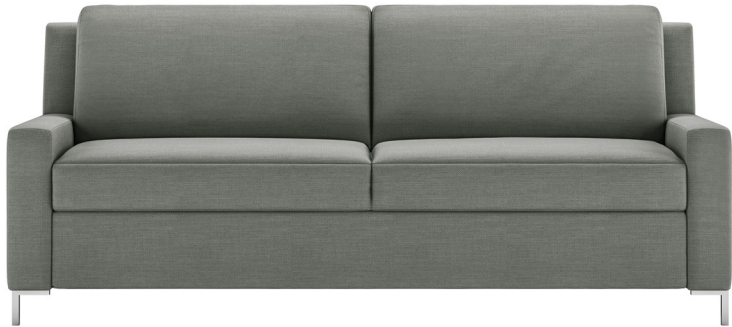

AMERICAN
LEATHER®

Standard Comfort Sleeper®

- Features:**
- Featuring the patented Tiffany 24/7™ platform sleep system
 - Room to stretch out with true 80 inches of bedroom-length sleeping surface
 - Ultimate comfort on four inches of plush, high-density foam mattress
 - Zero wall clearance
 - Quick-ship delivery
 - Double-needle top-stitch
 - High-density, high-resiliency foam seat cushions
 - Loose back and seat cushions
 - Lifetime warranty on frame
 - 10-year mechanism warranty
 - Stainless steel legs

Mattress Options:

- Premier with Crypton™ ticking
- Gel
- Tempur-Pedic®

Options:

- High-density, high-resiliency foam seat cushions encased in down and down back cushions available
- Wood legs available in Acorn, Espresso or Walnut finish

Please use actual leather, fabric, Crypton®, Sunbrella® and Ultrasuede® swatches when specifying furniture as the colors shown may vary due to the printing process.

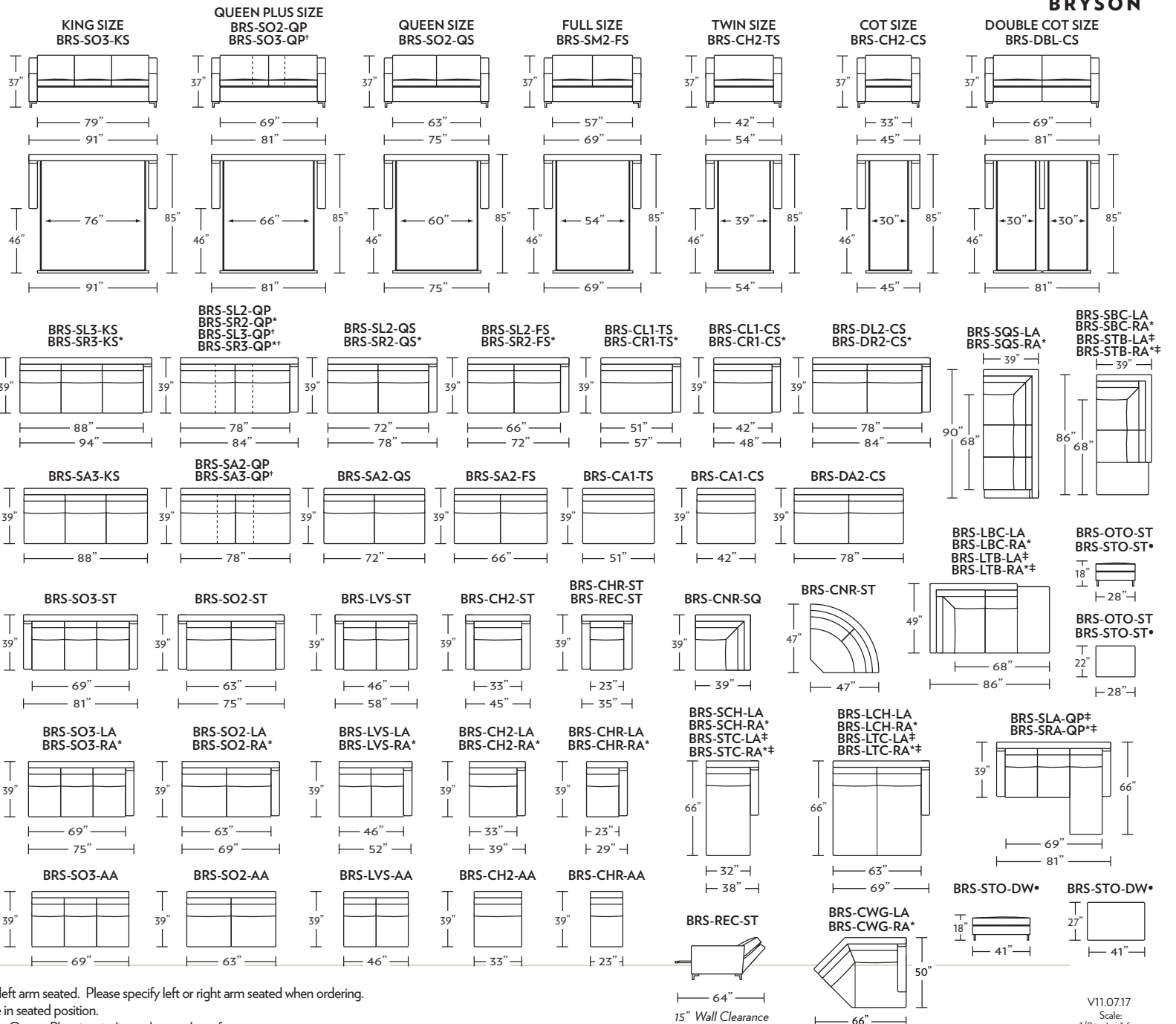
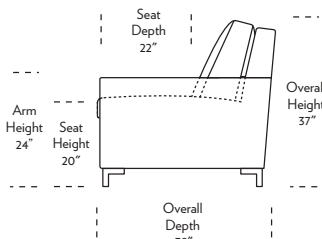

* Picture shows left arm seated. Please specify left or right arm seated when ordering.

All orders are in seated position.

† Dotted lines for Queen Plus sizes indicate the number of seats.

All dimensions are approximate and subject to change.

* Chaise lifts up to reveal hidden storage space. • Storage

COMFORT SLEEPER® BY AMERICAN LEATHER®

CONLEY



AMERICAN
LEATHER®

Standard Comfort Sleeper®

Features:

- Featuring the patented Tiffany 24/7™ platform sleep system
- Room to stretch out with true 80 inches of bedroom-length sleeping surface
- Ultimate comfort on four inches of plush, high-density foam mattress
- Zero wall clearance
- Quick-ship delivery
- Single-needle top-stitch
- High-density, high-resiliency foam seat cushions
- Loose back and seat cushions
- Lifetime warranty on frame
- 10-year mechanism warranty

Mattress Options:

- Premier with Crypton® ticking
- Gel
- Tempur-Pedic®

Options:

- High-density, high-resiliency foam seat cushions encased in down and down back cushions available
- Wood legs available in Acorn, Espresso, or Walnut finish
- Nailhead trim available in Antique Brass, Chrome or Pewter finish (arms and deck)

Please use actual leather, fabric, Crypton®, Sunbrella® and Ultrasuede® swatches when specifying furniture as the colors shown may vary due to the printing process.

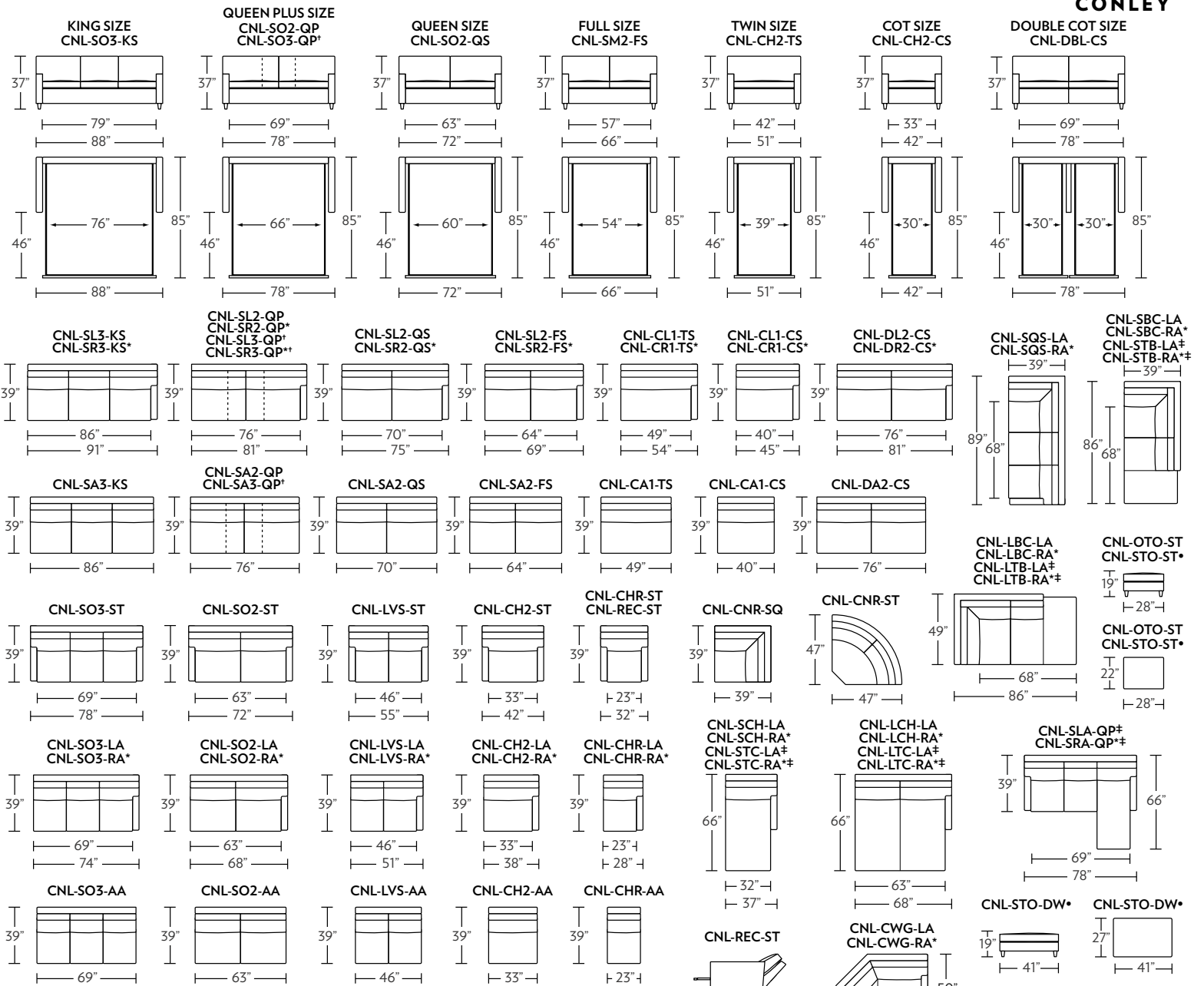
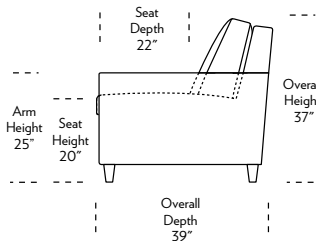

* Picture shows left arm seated. Please specify left or right arm seated when ordering.

All orders are in seated position.

† Dotted lines for Queen Plus sizes indicates the number of seats.

All dimensions are approximate and subject to change.

* Chaise lifts up to reveal hidden storage space. • Storage

Tiffany 24/7™ Convertible mechanism, U.S. Patents #6904628, #8893323, #9468303, #9668585. Additional patents pending.

V03.28.19
Scale:
1/8 inch = 1 foot

COMFORT SLEEPER® BY AMERICAN LEATHER®

GAINES



**AMERICAN
LEATHER®**

Standard Comfort Sleeper®

Features:

- Featuring the patented Tiffany 24/7™ platform sleep system
- Room to stretch out with true 80 inches of bedroom-length sleeping surface
- Ultimate comfort on five inches of plush, high-density foam mattress
- Under-sofa dust covers keeps dust and dirt from ever touching the mattress
- Zero wall clearance
- Quick-ship delivery
- Double-needle top-stitch
- High-density, high-resiliency foam seat cushions
- Loose back and seat cushions
- Lifetime warranty on frame
- 10-year mechanism warranty

Mattress Options:

- Premier with Crypton™ ticking
- Gel
- Tempur-Pedic®

Options:

- High-density, high-resiliency foam seat cushions encased in down and down back cushions available
- Wood legs available in Acorn, Espresso or Walnut finish
- Nailhead trim available in Antique Brass, Chrome or Pewter finish (arms and deck)

Please use actual leather, fabric, Crypton®, Sunbrella® and Ultrasuede® swatches when specifying furniture as the colors shown may vary due to the printing process.

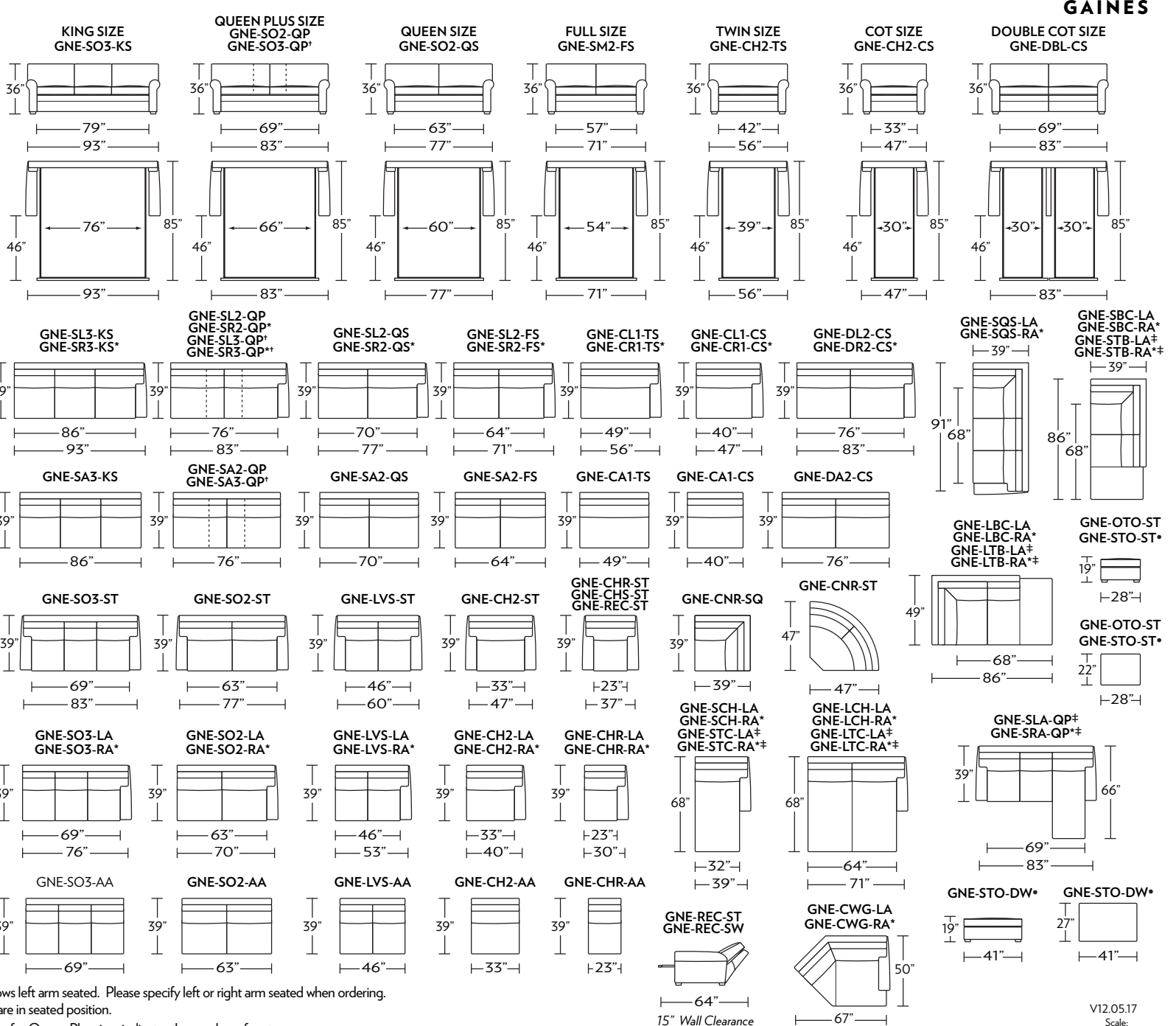
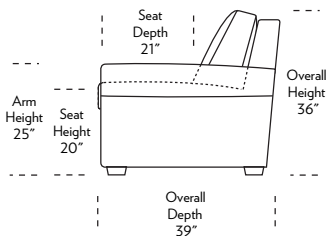

* Picture shows left arm seated. Please specify left or right arm seated when ordering.
 All orders are in seated position.
 † Dotted lines for Queen Plus sizes indicates the number of seats.
 All dimensions are approximate and subject to change.
 * Chaise lifts up to reveal hidden storage space. * Storage

COMFORT SLEEPER® BY AMERICAN LEATHER®

GIBBS



AMERICAN
LEATHER®

GIBBS

Standard Comfort Sleeper®

Features:

- Featuring the patented Tiffany 24/7™ platform sleep system
- Room to stretch out with true 80 inches of bedroom-length sleeping surface
- Ultimate comfort on four inches of plush, high-density foam mattress
- Zero wall clearance
- Quick-ship delivery
- Single-needle top-stitch
- High-density, high-resiliency foam seat cushions
- Loose back and seat cushions
- Lifetime warranty on frame
- 10-year mechanism warranty

Mattress Options:

- Premier with Crypton™ ticking
- Gel
- Tempur-Pedic®

Options:

- High-density, high-resiliency foam seat cushions encased in down and down back cushions available
- Wood legs available in Acorn, Espresso or Walnut finish
- Nailhead trim available in Antique Brass, Chrome or Pewter finish (arms and deck)

Please use actual leather, fabric, Crypton®, Sunbrella® and Ultrasuede® swatches when specifying furniture as the colors shown may vary due to the printing process.

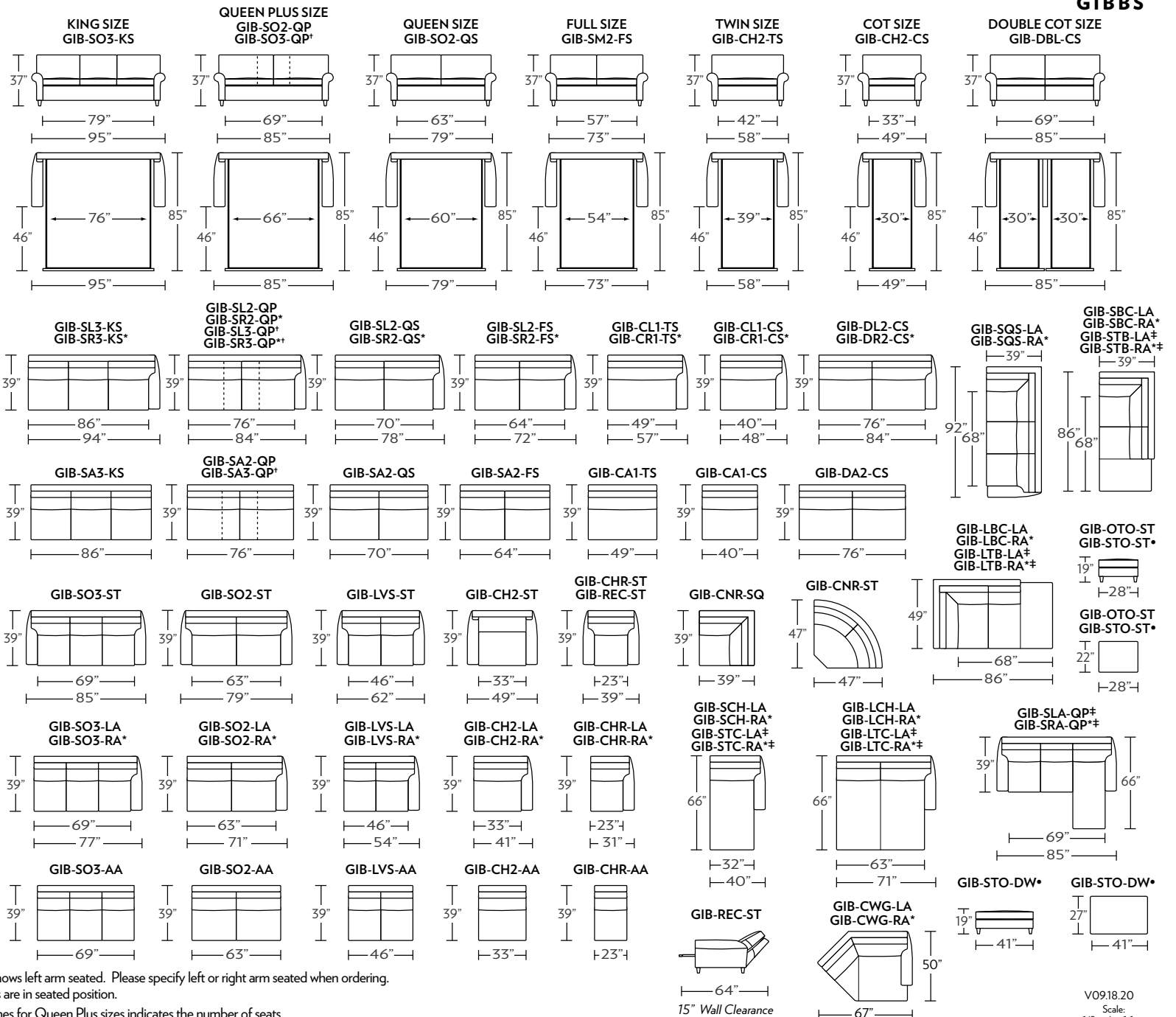
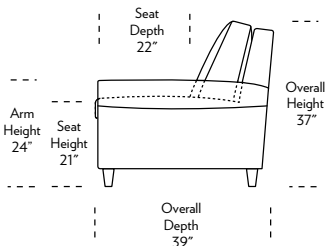

* Picture shows left arm seated. Please specify left or right arm seated when ordering.
All orders are in seated position.

† Dotted lines for Queen Plus sizes indicates the number of seats.
All dimensions are approximate and subject to change.

‡ Chaise lifts up to reveal hidden storage space. • Storage

COMFORT SLEEPER® BY AMERICAN LEATHER®

HARRIS



**AMERICAN
LEATHER®**

Standard Comfort Sleeper®

Features:

- Featuring the patented Tiffany 24/7™ platform sleep system
- Room to stretch out with true 80 inches of bedroom-length sleeping surface
- Ultimate comfort on four inches of plush, high-density foam mattress
- Zero wall clearance
- Quick-ship delivery
- Single-needle top-stitch
- High-density, high-resiliency foam seat cushions
- Loose back and seat cushions
- Lifetime warranty on frame
- 10-year mechanism warranty

Mattress Options:

- Premier with Crypton™ ticking
- Gel
- Tempur-Pedic®

Options:

- High-density, high-resiliency foam seat cushions encased in down and down back cushions available
- Wood legs available in Acorn, Espresso or Walnut finish
- Nailhead trim available in Antique Brass, Chrome or Pewter finish (deck only)

Please use actual leather, fabric, Crypton®, Sunbrella® and Ultrasuede® swatches when specifying furniture as the colors shown may vary due to the printing process.

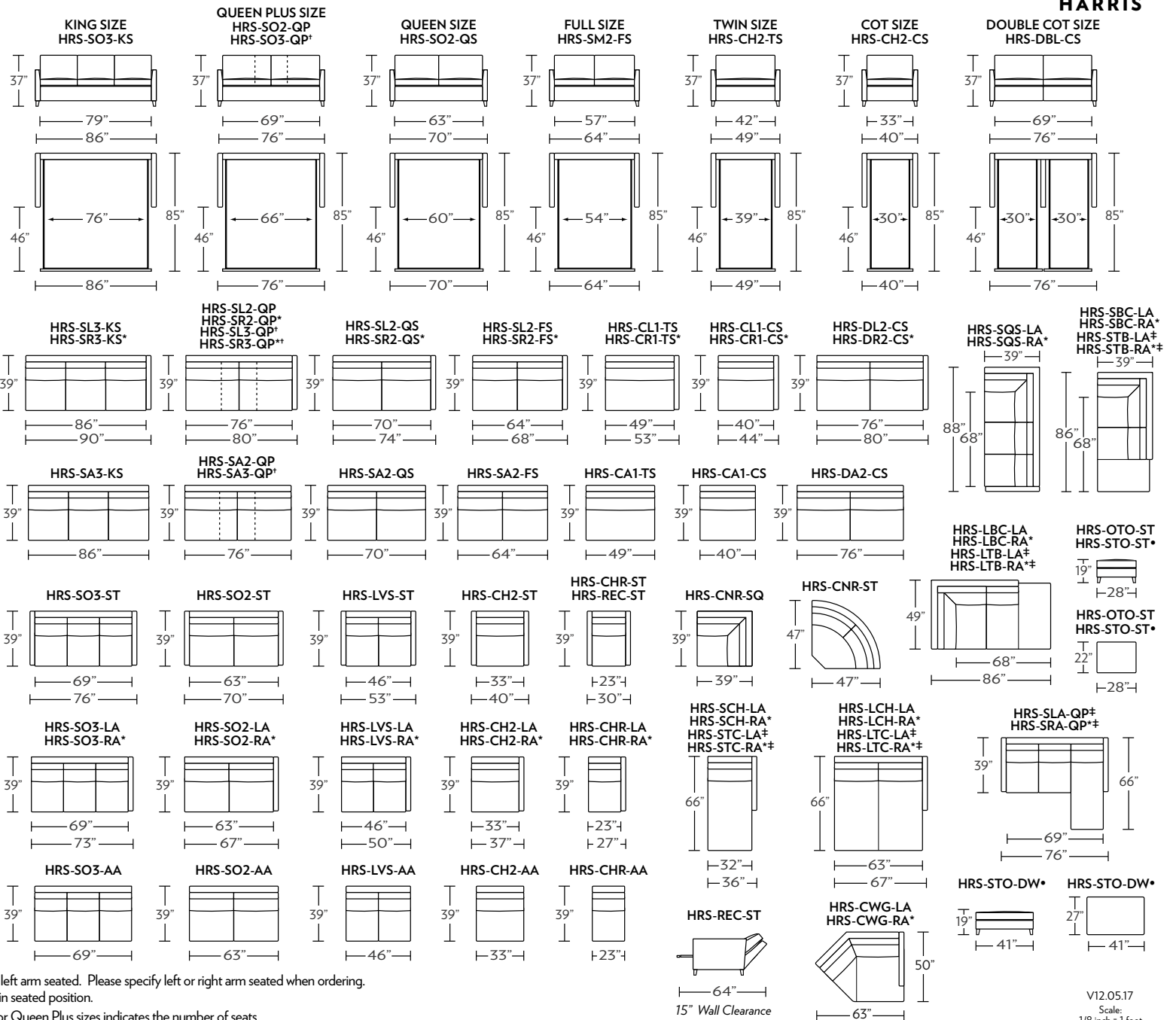
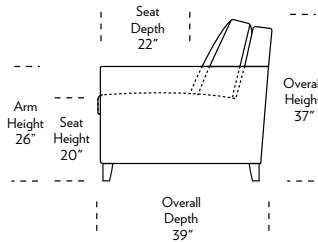

* Picture shows left arm seated. Please specify left or right arm seated when ordering.
All orders are in seated position.

† Dotted lines for Queen Plus sizes indicates the number of seats.

All dimensions are approximate and subject to change.

‡ Chaise lifts up to reveal hidden storage space. • Storage

Tiffany 24/7™ Convertible mechanism, U.S. Patents #6904628, #8893323, #9468303, #9668585.
Additional patents pending.

V12.05.17
Scale:
1/8 inch = 1 foot

COMFORT SLEEPER® BY AMERICAN LEATHER®

KLEIN



**AMERICAN
LEATHER®**

Standard Comfort Sleeper®

Features:

- Featuring the patented Tiffany 24/7™ platform sleep system
- Room to stretch out with true 80 inches of bedroom-length sleeping surface
- Ultimate comfort on five inches of plush, high-density foam mattress
- Under-sofa dust covers keeps dust and dirt from ever touching the mattress
- Zero wall clearance
- Quick-ship delivery
- Double-needle top-stitch
- High-density, high-resiliency foam seat cushions
- Loose back and seat cushions
- Lifetime warranty on frame
- 10-year mechanism warranty

Mattress Options:

- Premier with Crypton™ ticking
- Gel
- Tempur-Pedic®

Options:

- High-density, high-resiliency foam seat cushions encased in down and down back cushions available
- Wood legs available in Acorn, Espresso or Walnut finish
- Nailhead trim available in Antique Brass, Chrome or Pewter finish (arms and deck)

Please use actual leather, fabric, Crypton®, Sunbrella® and Ultrasuede® swatches when specifying furniture as the colors shown may vary due to the printing process.

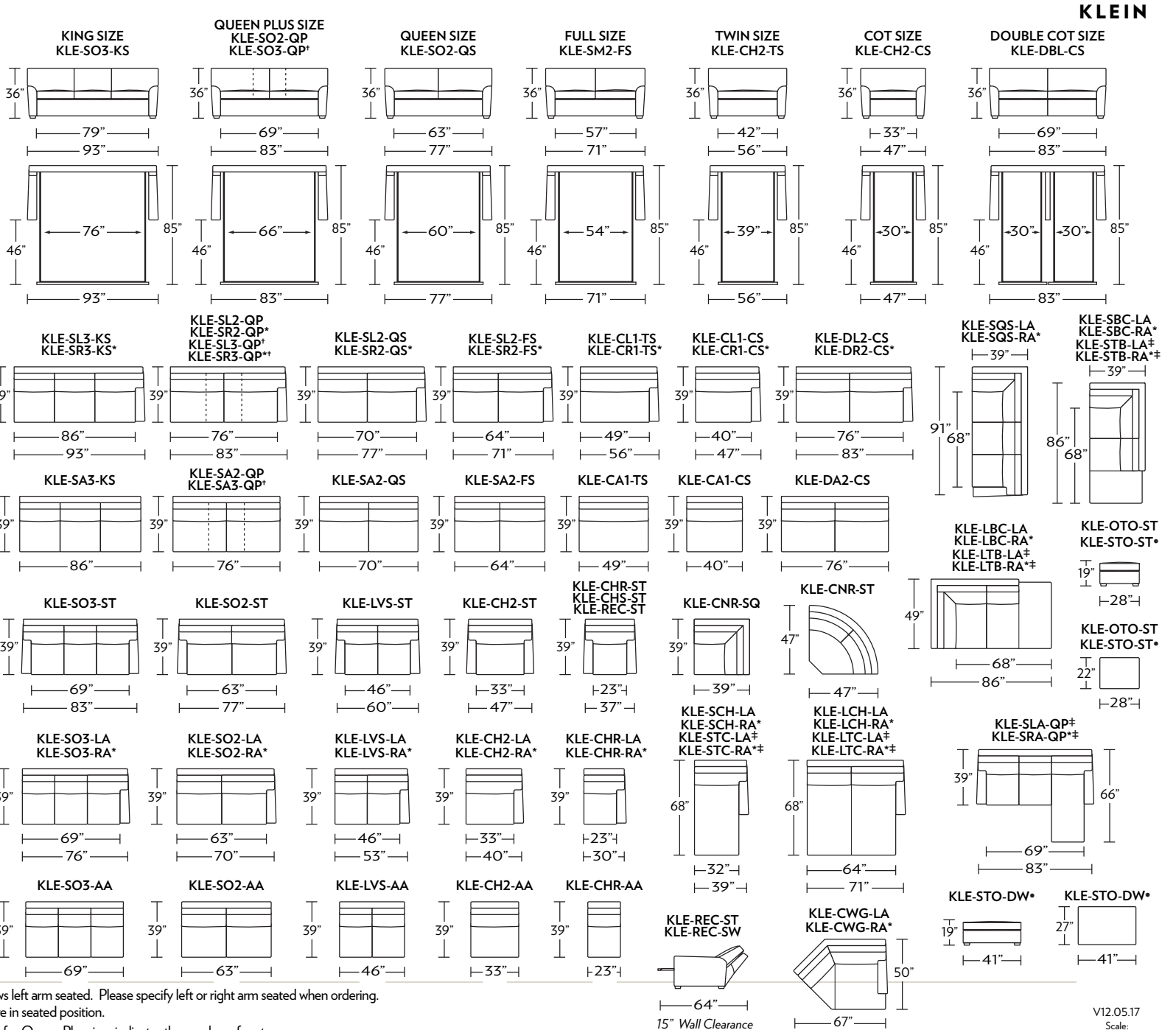
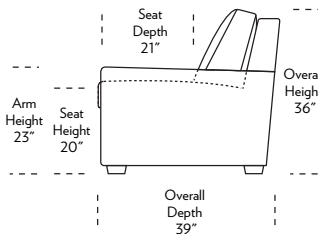

* Picture shows left arm seated. Please specify left or right arm seated when ordering.
All orders are in seated position.

† Dotted lines for Queen Plus sizes indicates the number of seats.

All dimensions are approximate and subject to change.

‡ Chaise lifts up to reveal hidden storage space. • Storage

COMFORT SLEEPER® BY AMERICAN LEATHER®

LYONS



**AMERICAN
LEATHER®**

LYONS

Standard Comfort Sleeper®

Features:

- Featuring the patented Tiffany 24/7™ platform sleep system
- Room to stretch out with true 80 inches of bedroom-length sleeping surface
- Ultimate comfort on five inches of plush, high-density foam mattress
- Under-sofa dust covers keeps dust and dirt from ever touching the mattress
- Zero wall clearance
- Quick-ship delivery
- Single-needle top-stitch
- High-density, high-resiliency foam seat cushions
- Loose back and seat cushions
- Lifetime warranty on frame
- 10-year mechanism warranty

Mattress Options:

- Premier with Crypton™ ticking
- Gel
- Tempur-Pedic®

Options:

- High-density, high-resiliency foam seat cushions encased in down and down back cushions available
- Wood legs available in Acorn, Espresso or Walnut finish
- Nailhead trim available in Antique Brass, Chrome or Pewter finish (deck only)

Please use actual leather, fabric, Crypton®, Sunbrella® and Ultrasuede® swatches when specifying furniture as the colors shown may vary due to the printing process.

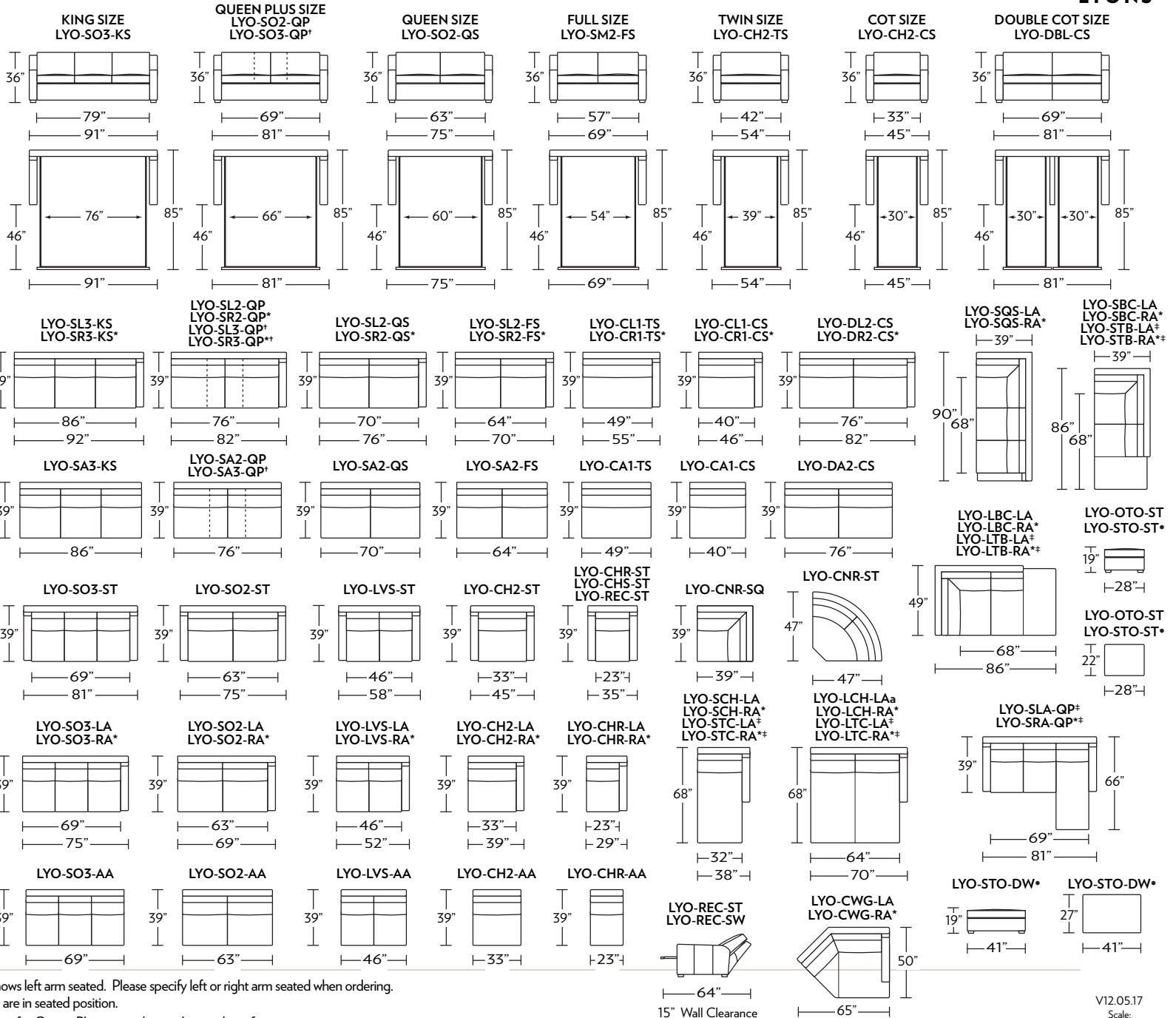
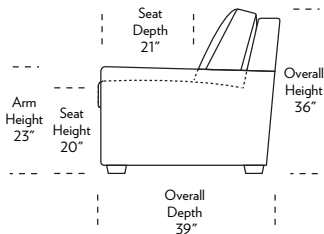

* Picture shows left arm seated. Please specify left or right arm seated when ordering. All orders are in seated position.

† Dotted lines for Queen Plus sizes indicates the number of seats.

All dimensions are approximate and subject to change.

‡ Chaise lifts up to reveal hidden storage space. • Storage

COMFORT SLEEPER® BY AMERICAN LEATHER®

MADDEN



AMERICAN
LEATHER®

MADDEN

Standard Comfort Sleeper®

Features:

- Featuring the patented Tiffany 24/7™ platform sleep system
- Room to stretch out with true 80 inches of bedroom-length sleeping surface
- Ultimate comfort on five inches of plush, high-density foam mattress
- Under-sofa dust covers keeps dust and dirt from ever touching the mattress
- Zero wall clearance
- Quick-ship delivery
- Flat French welt
- High-density, high-resiliency foam seat cushions
- Loose back and seat cushions
- Lifetime warranty on frame
- 10-year mechanism warranty

Mattress Options:

- Premier with Crypton™ ticking
- Gel
- Tempur-Pedic®

Options:

- High-density, high-resiliency foam seat cushions encased in down and down back cushions available
- Wood legs available in Acorn, Espresso or Walnut finish

Please use actual leather, fabric, Crypton®, Sunbrella® and Ultrasuede® swatches when specifying furniture as the colors shown may vary due to the printing process.

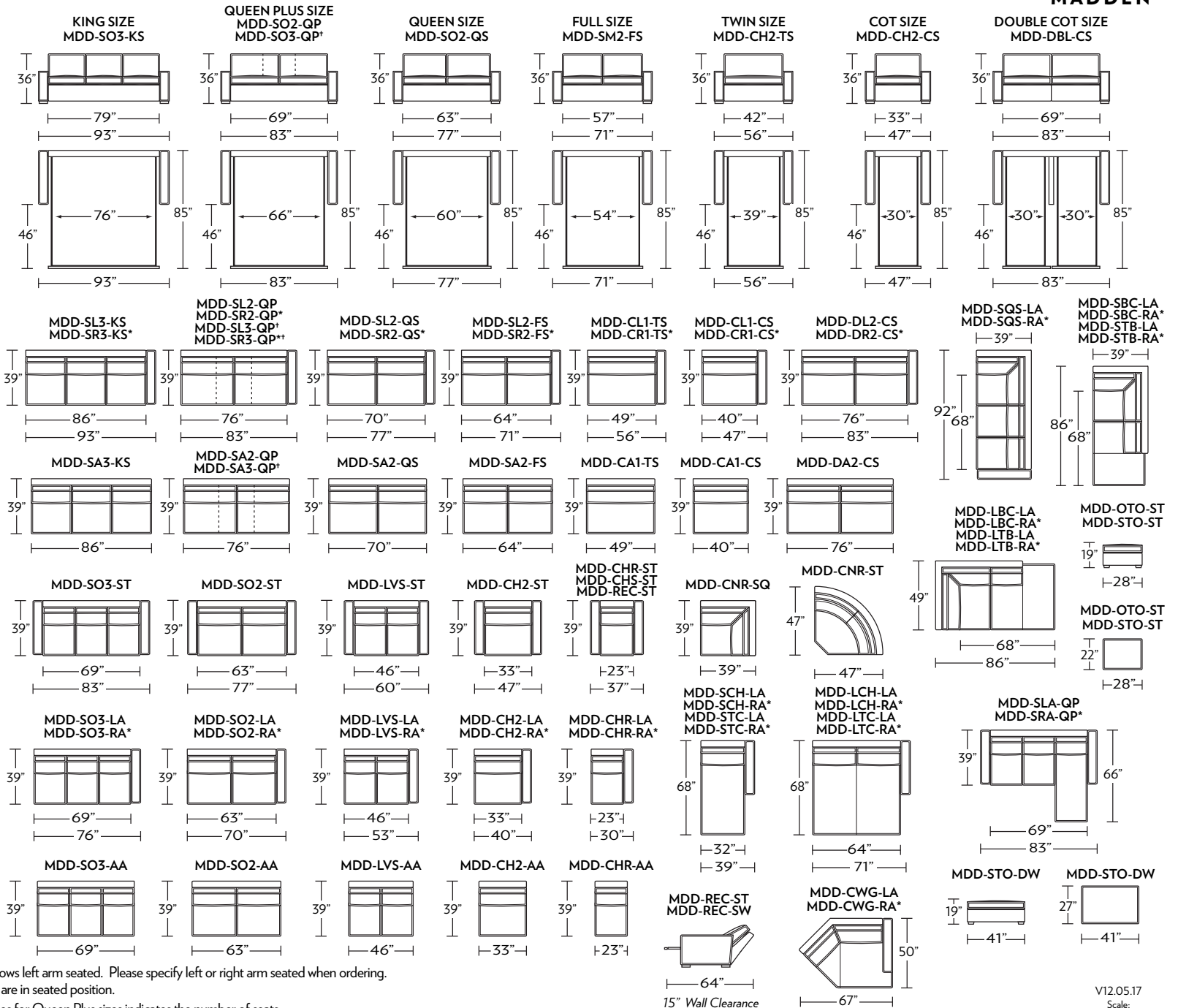
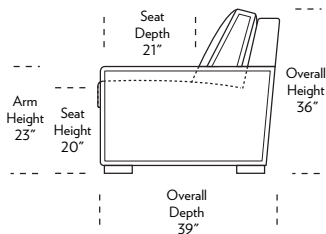

* Picture shows left arm seated. Please specify left or right arm seated when ordering.

† All orders are in seated position.

‡ Dotted lines for Queen Plus sizes indicates the number of seats.

§ All dimensions are approximate and subject to change.

¶ Chaise lifts up to reveal hidden storage space. • Storage

COMFORT SLEEPER® BY AMERICAN LEATHER®

MITCHELL



**AMERICAN
LEATHER®**

Standard Comfort Sleeper®

Features:

- Featuring the patented Tiffany 24/7™ platform sleep system
- Room to stretch out with true 80 inches of bedroom-length sleeping surface
- Ultimate comfort on four inches of plush, high-density foam mattress
- Zero wall clearance
- Quick-ship delivery
- Flat French welt
- High-density, high-resiliency foam seat cushions
- Loose back and seat cushions
- Lifetime warranty on frame
- 10-year mechanism warranty

Mattress Options:

- Premier with Crypton® ticking
- Gel
- Tempur-Pedic®

Options:

- High-density, high-resiliency foam seat cushions encased in down and down back cushions available
- Wood legs available in Acorn, Espresso or Walnut finish

Please use actual leather, fabric, Crypton®, Sunbrella® and Ultrasuede® swatches when specifying furniture as the colors shown may vary due to the printing process.

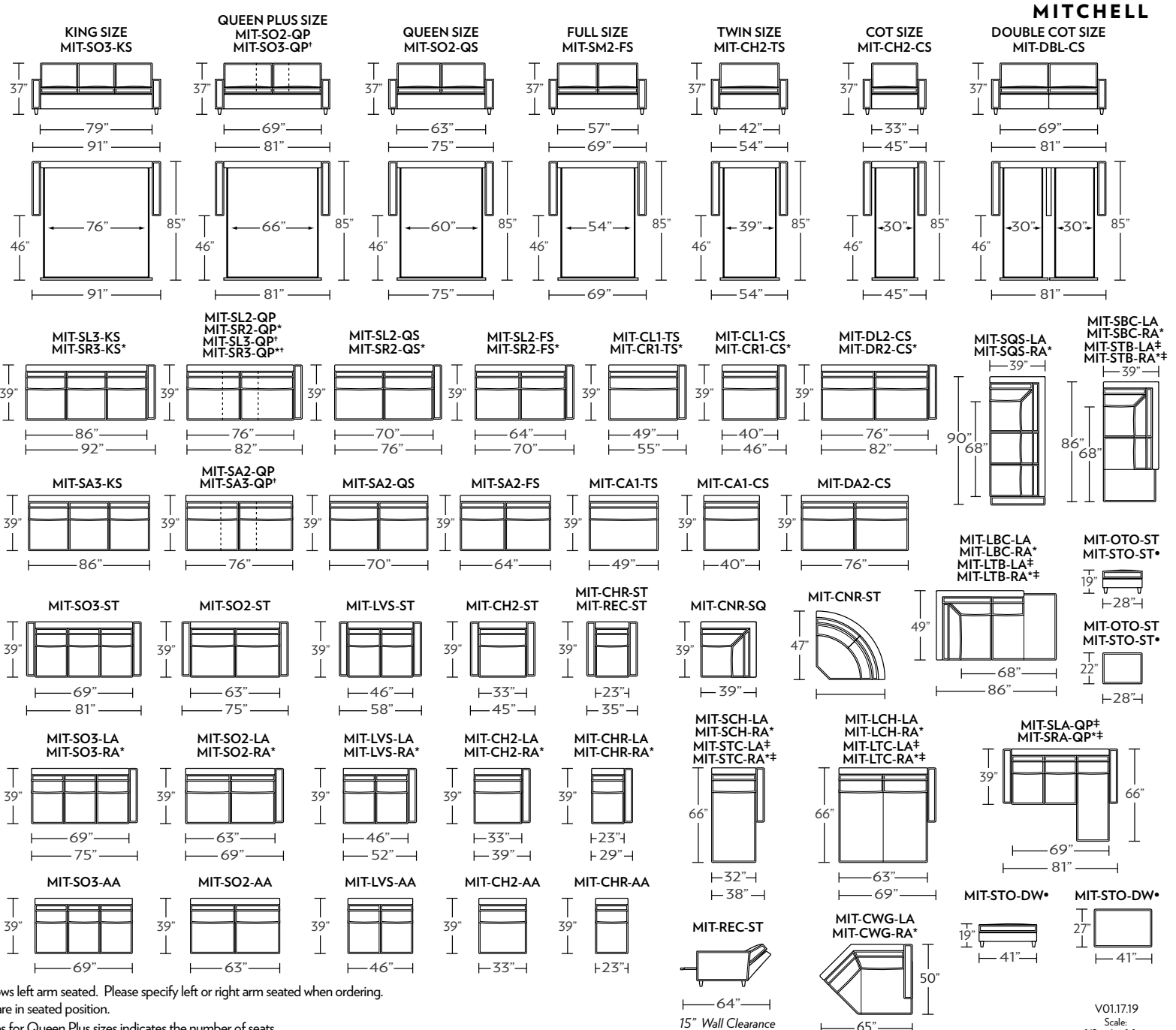
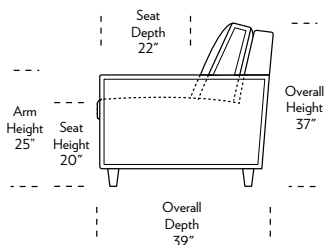

* Picture shows left arm seated. Please specify left or right arm seated when ordering.

All orders are in seated position.

† Dotted lines for Queen Plus sizes indicates the number of seats.

All dimensions are approximate and subject to change.

‡ Chaise lifts up to reveal hidden storage space. • Storage

Tiffany 24/7™ Convertible mechanism, U.S. Patents #6904628, #8893323, #9468303, #9668585. Additional patents pending.

V01.17.19
Scale:
1/8 inch = 1 foot

COMFORT SLEEPER® BY AMERICAN LEATHER®

OLSON



**AMERICAN
LEATHER®**

OLSON

Standard Comfort Sleeper®

Features:

- Featuring the patented Tiffany 24/7™ platform sleep system
- Room to stretch out with true 80 inches of bedroom-length sleeping surface
- Ultimate comfort on five inches of plush, high-density foam mattress
- Under-sofa dust covers keeps dust and dirt from ever touching the mattress
- Zero wall clearance
- Quick-ship delivery
- Double-needle top-stitch
- High-density, high-resiliency foam seat cushions
- Loose back and seat cushions
- Lifetime warranty on frame
- 10-year mechanism warranty

Mattress Options:

- Premier with Crypton™ ticking
- Gel
- Tempur-Pedic®

Options:

- High-density, high-resiliency foam seat cushions encased in down and down back cushions available
- Wood legs available in Acorn, Espresso or Walnut finish
- Nailhead trim available in Antique Brass, Chrome or Pewter finish (deck only)

Please use actual leather, fabric, Crypton®, Sunbrella® and Ultrasuede® swatches when specifying furniture as the colors shown may vary due to the printing process.

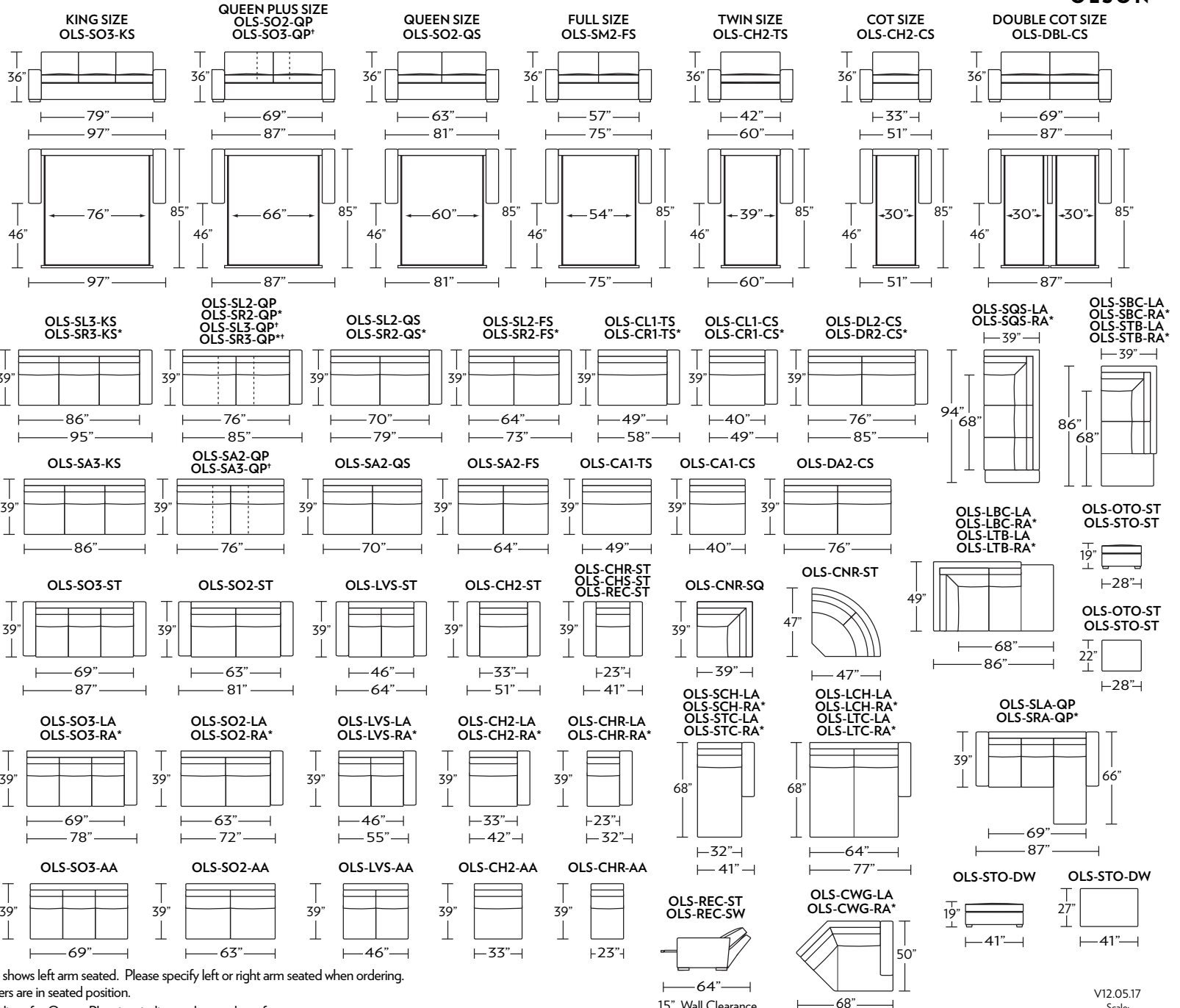
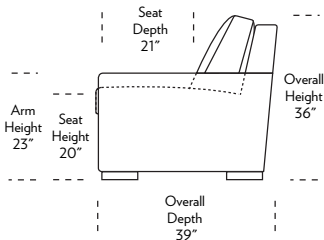

* Picture shows left arm seated. Please specify left or right arm seated when ordering.
 † All orders are in seated position.
 ‡ Dotted lines for Queen Plus sizes indicates the number of seats.
 All dimensions are approximate and subject to change.
 † Chaise lifts up to reveal hidden storage space. • Storage

COMFORT SLEEPER® BY AMERICAN LEATHER®

PEARSON



AMERICAN
LEATHER®

Standard Comfort Sleeper®

Features:

- Featuring the patented Tiffany 24/7™ platform sleep system
- Room to stretch out with true 80 inches of bedroom-length sleeping surface
- Ultimate comfort on five inches of plush, high-density foam mattress
- Under-sofa dust covers keeps dust and dirt from ever touching the mattress
- Zero wall clearance
- Quick-ship delivery
- Single-needle top-stitch
- High-density, high-resiliency foam seat cushions
- Loose back and seat cushions
- Lifetime warranty on frame
- 10-year mechanism warranty

Mattress Options:

- Premier with Crypton™ ticking
- Gel
- Tempur-Pedic®

Options:

- High-density, high-resiliency foam seat cushions encased in down and down back cushions available
- Wood legs available in Acorn, Espresso or Walnut finish
- Nailhead trim available in Antique Brass, Chrome or Pewter finish (deck only)

Please use actual leather, fabric, Crypton®, Sunbrella® and Ultrasuede® swatches when specifying furniture as the colors shown may vary due to the printing process.

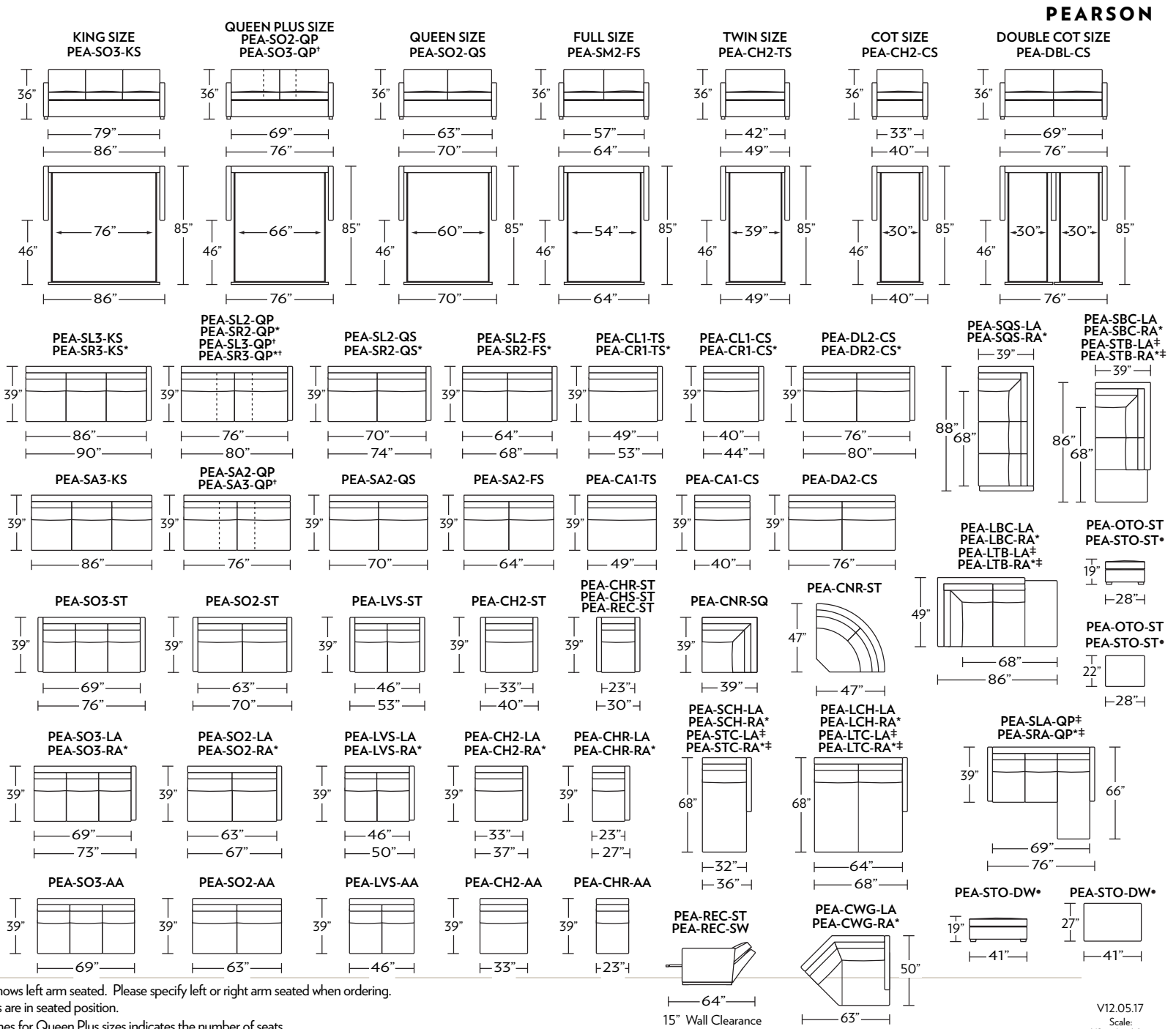
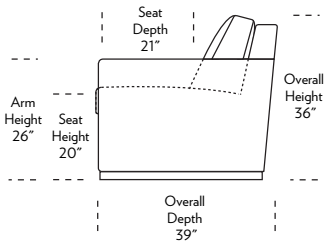

* Picture shows left arm seated. Please specify left or right arm seated when ordering.
 All orders are in seated position.
 † Dotted lines for Queen Plus sizes indicates the number of seats.
 All dimensions are approximate and subject to change.
 ‡ Chaise lifts up to reveal hidden storage space. • Storage

COMFORT SLEEPER® BY AMERICAN LEATHER®

PERRY



AMERICAN
LEATHER®

PERRY

Standard Comfort Sleeper®

Features:

- Featuring the patented Tiffany 24/7™ platform sleep system
- Room to stretch out with true 80 inches of bedroom-length sleeping surface
- Ultimate comfort on five inches of plush, high-density foam mattress
- Under-sofa dust covers keeps dust and dirt from ever touching the mattress
- Zero wall clearance
- Quick-ship delivery
- Single-needle top-stitch
- High-density, high-resiliency foam seat cushions
- Loose back and seat cushions
- Lifetime warranty on frame
- 10-year mechanism warranty

Mattress Options:

- Premier with Crypton™ ticking
- Gel
- Tempur-Pedic®

Options:

- High-density, high-resiliency foam seat cushions encased in down and down back cushions available
- Wood legs available in Acorn, Espresso or Walnut finish
- Nailhead trim available in Antique Brass, Chrome or Pewter finish (arms and deck)

Please use actual leather, fabric, Crypton®, Sunbrella® and Ultrasuede® swatches when specifying furniture as the colors shown may vary due to the printing process.

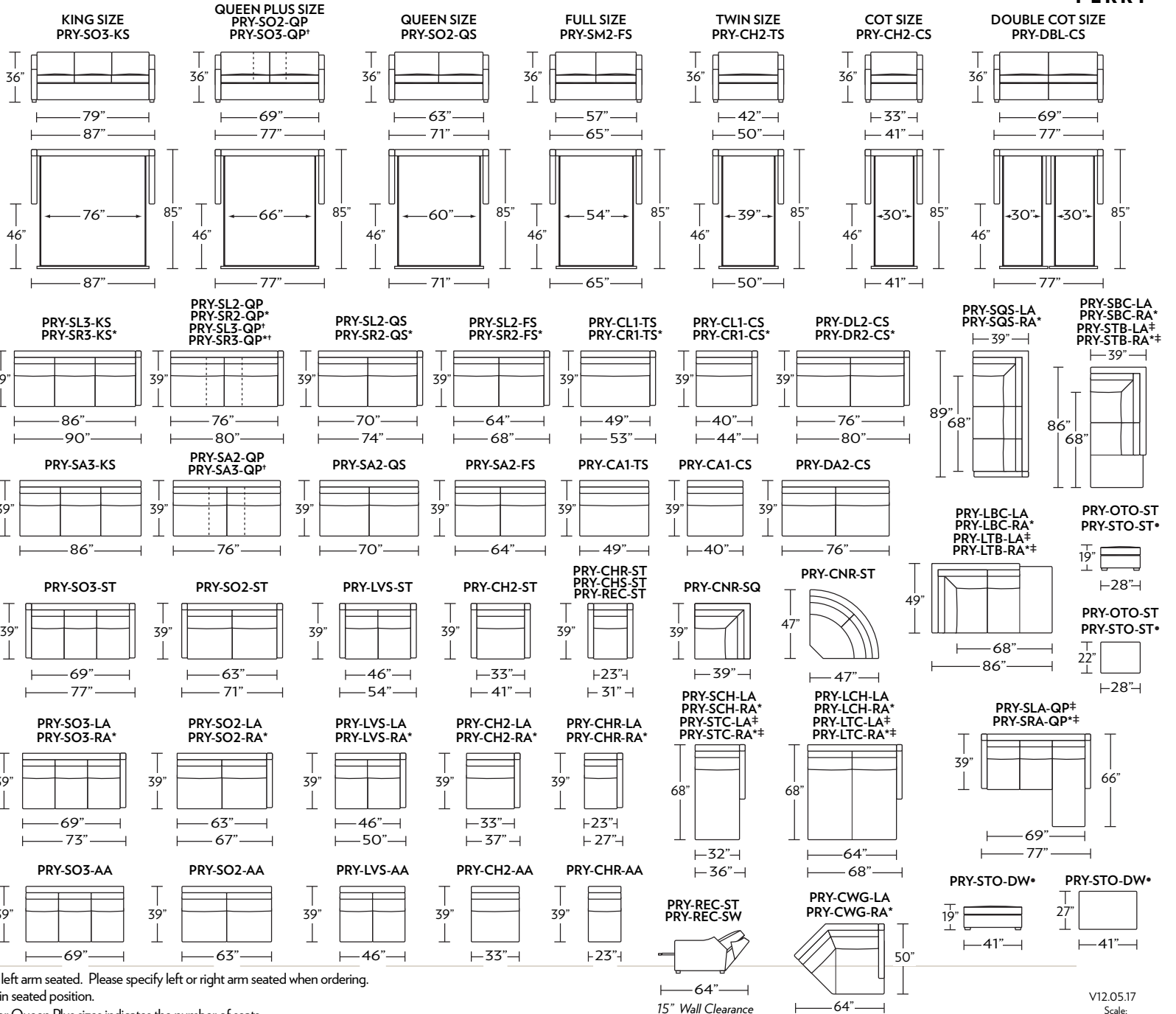
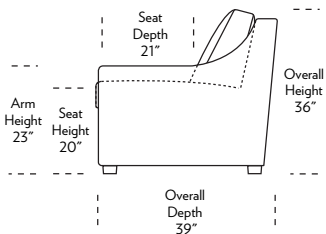

* Picture shows left arm seated. Please specify left or right arm seated when ordering.
 All orders are in seated position.
 † Dotted lines for Queen Plus sizes indicates the number of seats.
 All dimensions are approximate and subject to change.
 ‡ Chaise lifts up to reveal hidden storage space. • Storage

COMFORT SLEEPER® BY AMERICAN LEATHER®

ROGUE



AMERICAN
LEATHER®

Standard Comfort Sleeper®

Features:

- Featuring the patented Tiffany 24/7™ platform sleep system
- Room to stretch out with true 80 inches of bedroom-length sleeping surface
- Ultimate comfort on five inches of plush, high-density foam mattress
- Under-sofa dust covers keeps dust and dirt from ever touching the mattress
- Zero wall clearance
- High-density, high-resiliency foam seat cushions
- Loose back and seat cushions
- Lifetime warranty on frame
- 10-year mechanism warranty

Mattress Options:

- Premier with Crypton® ticking
- Gel
- Tempur-Pedic®

Options:

- High-density, high-resiliency foam seat cushions encased in down and down back cushions available
- Wood legs available in Acorn, Espresso or Walnut finish

Please use actual leather, fabric, Crypton®, Sunbrella® and Ultrasuede® swatches when specifying furniture as the colors shown may vary due to the printing process.

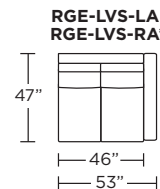
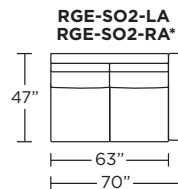
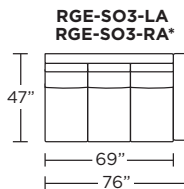
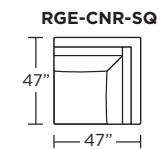
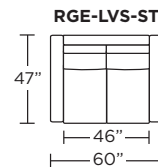
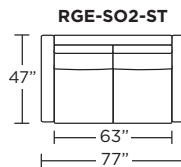
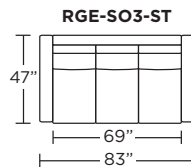
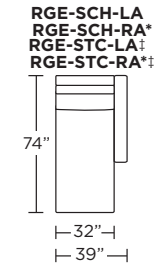
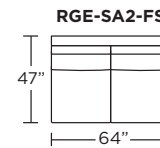
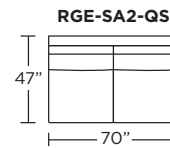
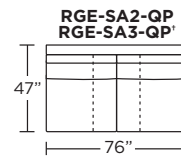
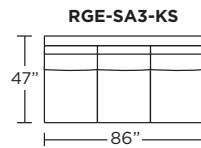
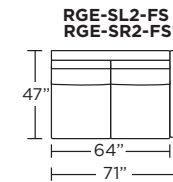
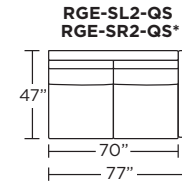
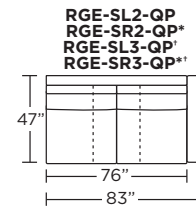
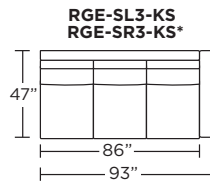
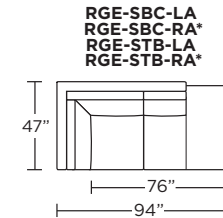
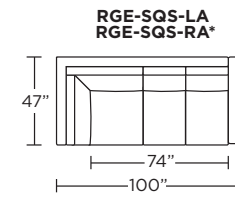
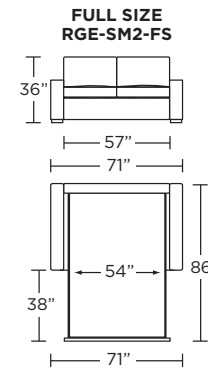
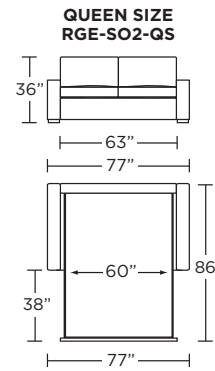
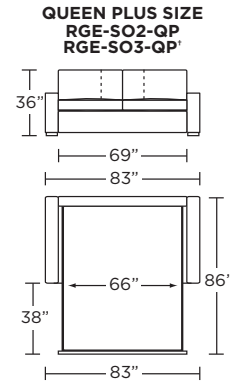
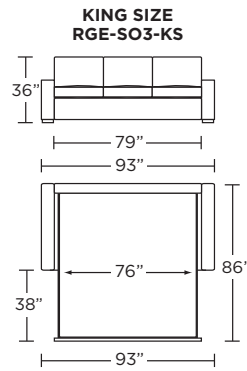
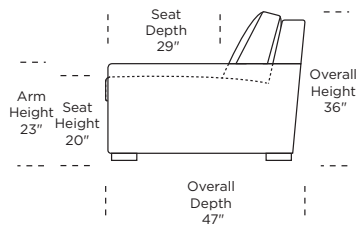

* Picture shows left arm seated. Please specify left or right arm seated when ordering. All orders are in seated position.

† Dotted lines for Queen Plus sizes indicates the number of seats.

All dimensions are approximate and subject to change.

‡ Chaise lifts up to reveal hidden storage space.

COMFORT SLEEPER® BY AMERICAN LEATHER®

SULLEY



**AMERICAN
LEATHER®**

SULLEY

Standard Comfort Sleeper®

Features:

- Featuring the patented Tiffany 24/7™ platform sleep system
- Room to stretch out with true 80 inches of bedroom-length sleeping surface
- Ultimate comfort on four inches of plush, high-density foam mattress
- Zero wall clearance
- Quick-ship delivery
- Double-needle top-stitch
- High-density, high-resiliency foam seat cushions
- Loose back and seat cushions
- Lifetime warranty on frame
- 10-year mechanism warranty
- Brushed stainless steel leg

Mattress Options:

- Premier with Crypton™ ticking
- Gel
- Tempur-Pedic™

Options:

- High-density, high-resiliency foam seat cushions encased in down and down back cushions available

Please use actual leather, fabric, Crypton®, Sunbrella® and Ultrasuede® swatches when specifying furniture as the colors shown may vary due to the printing process.

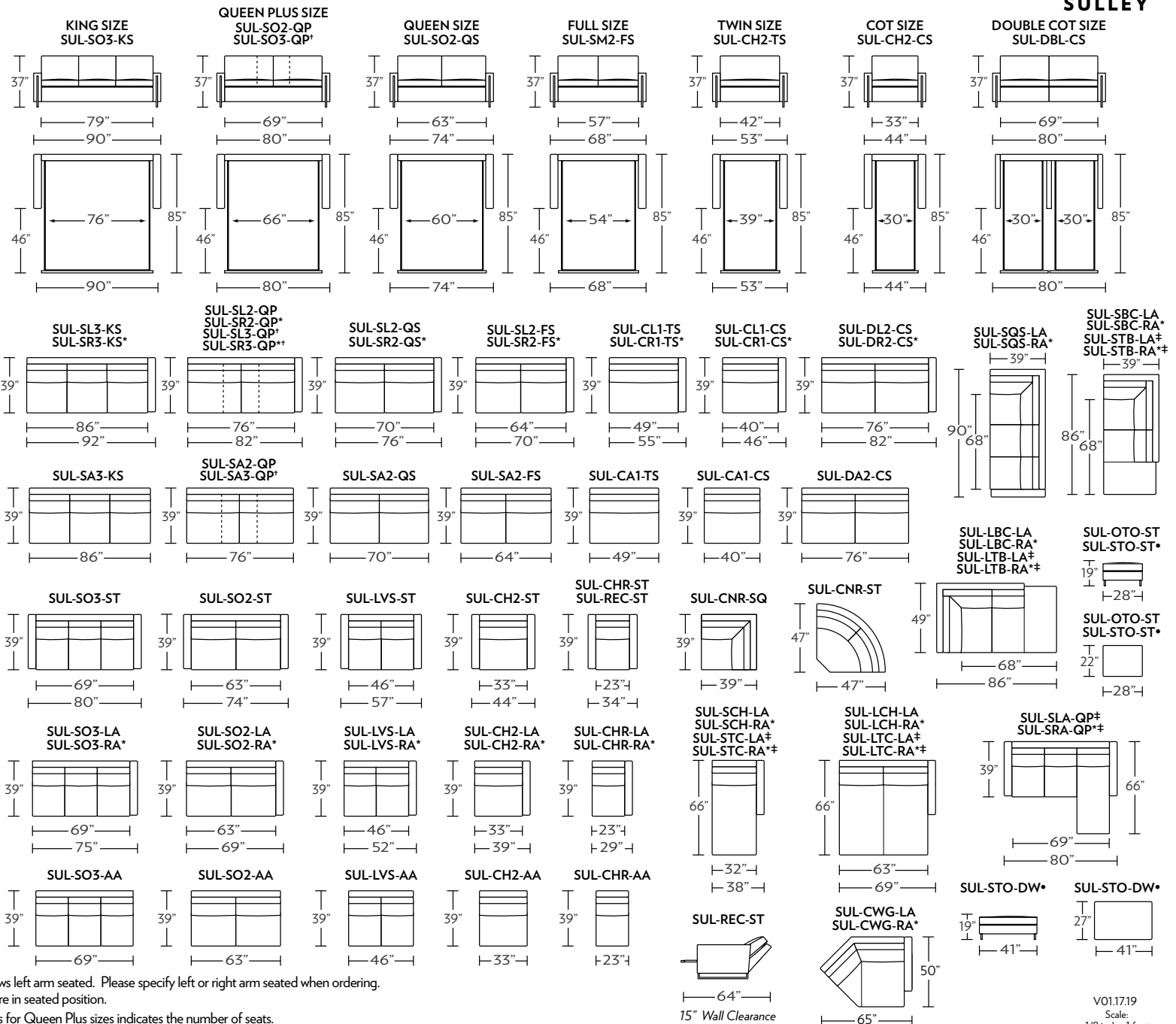
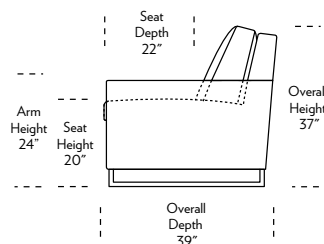

* Picture shows left arm seated. Please specify left or right arm seated when ordering.

All orders are in seated position.

† Dotted lines for Queen Plus sizes indicates the number of seats.

All dimensions are approximate and subject to change.

‡ Chaise lifts up to reveal hidden storage space. • Storage

AMERICAN LEATHER PRODUCT CATALOG

SILVER SLEEPER

AMERICAN
LEATHER®

COMFORT SLEEPER® COLLECTION | SILVER

PAIGE



**AMERICAN
LEATHER®**

COMFORT SLEEPER BY AMERICAN LEATHER® SILVER

PAIGE

Standard Features:

- Premium high-density, high-resiliency foam
- Loose back and seat cushions
- Fall away back becomes mattress section
- Zero wall clearance
- Single needle top-stitch
- Lifetime warranty on frame
- Limited five-year warranty on mechanism
- Quick-ship delivery

Options:

- Wood legs in Acorn, Espresso or Walnut finish

Mattress Options:

- Four inches of high-density, high-resiliency foam
- Four inches of plush, high-density foam with a cooling gel topper

Please use actual leather, fabric, Crypton®, Sunbrella® and Ultrasuede® swatches when specifying furniture as the colors shown may vary due to the printing process.

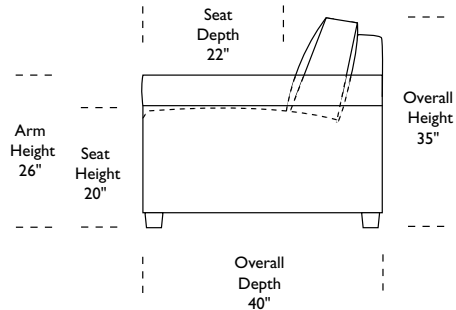
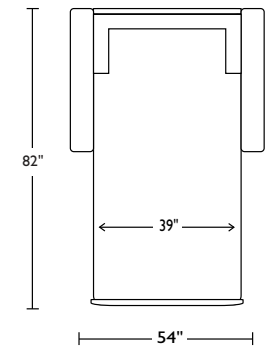
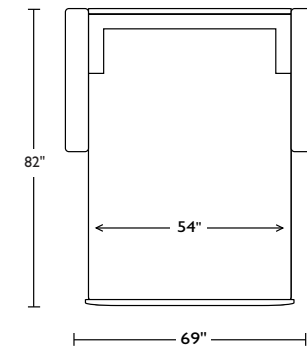
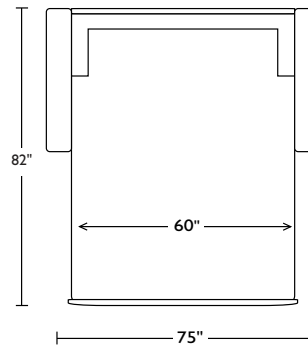
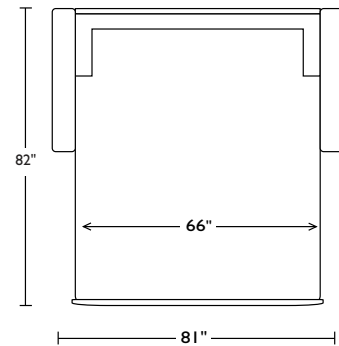
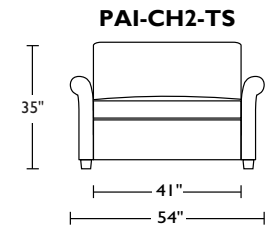
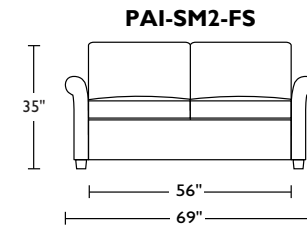
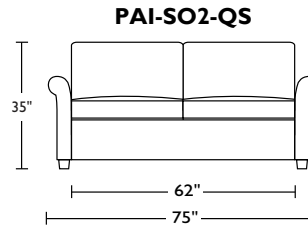
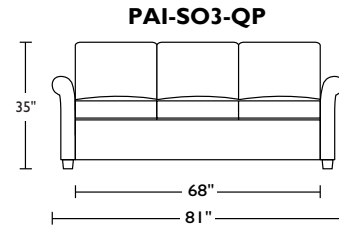

Scale: 1/4 inch = 1 foot
All dimensions are approximate and subject to change.
Specify components from the sitting position.
U.S. patents #6904628 & 8011034

V04.30.19

COMFORT SLEEPER® COLLECTION | SILVER

PALMER



**AMERICAN
LEATHER®**

COMFORT SLEEPER BY AMERICAN LEATHER® SILVER

PALMER

Standard Features:

- Premium high-density, high-resiliency foam
- Loose back and seat cushions
- Fall away back becomes mattress section
- Zero wall clearance
- Single needle top-stitch
- Lifetime warranty on frame
- Limited five-year warranty on mechanism
- Quick-ship delivery

Options:

- Wood legs in Acorn, Espresso or Walnut finish

Mattress Options:

- Four inches of high-density, high-resiliency foam
- Four inches of plush, high-density foam with a cooling gel topper

Please use actual leather, fabric, Crypton®, Sunbrella® and Ultrasuede® swatches when specifying furniture as the colors shown may vary due to the printing process.

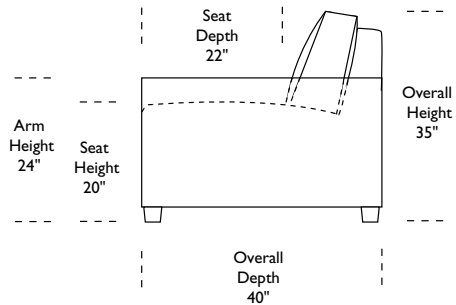
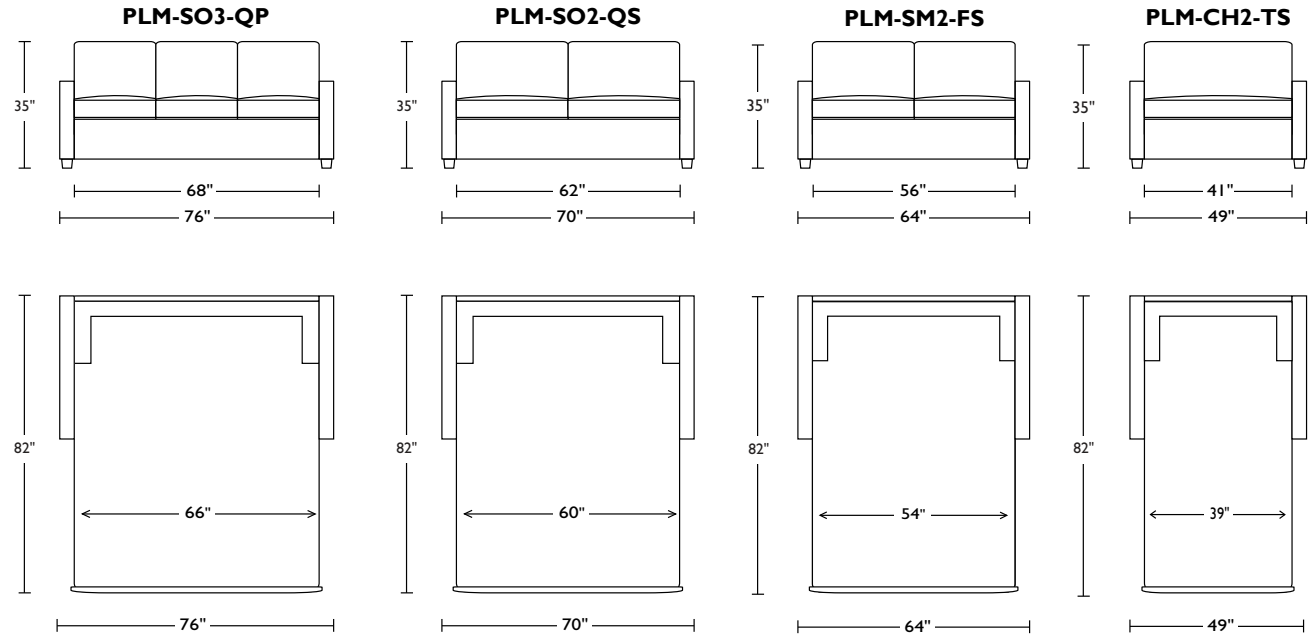

Scale: 1/4 inch = 1 foot
 All dimensions are approximate and subject to change.
 Specify components from the sitting position.
 U.S. patents #6904628 & 8011034

V04.30.19

COMFORT SLEEPER® COLLECTION | SILVER

PORTER



**AMERICAN
LEATHER®**

COMFORT SLEEPER BY AMERICAN LEATHER®
SILVER

PORTER

Standard Features:

- Premium high-density, high-resiliency foam
- Loose back and seat cushions
- Fall away back becomes mattress section
- Zero wall clearance
- Single needle top-stitch
- Lifetime warranty on frame
- Limited five-year warranty on mechanism
- Quick-ship delivery

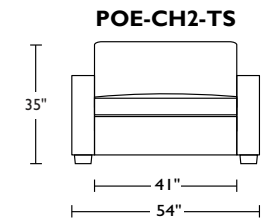
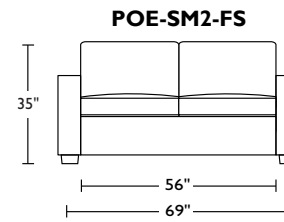
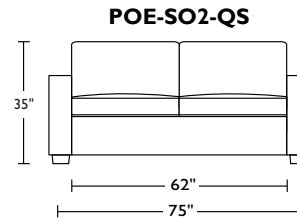
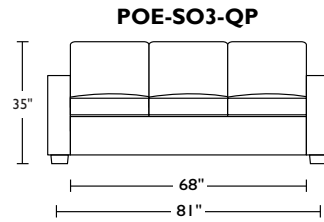

Options:

- Wood legs in Acorn, Espresso or Walnut finish

Mattress Options:

- Four inches of high-density, high-resiliency foam
- Four inches of plush, high-density foam with a cooling gel topper

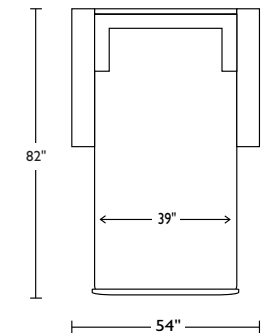
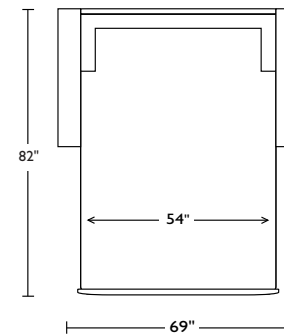
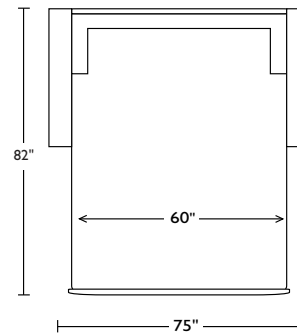
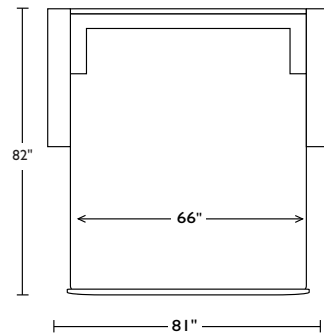

Please use actual leather, fabric, Crypton®, Sunbrella® and Ultrasuede® swatches when specifying furniture as the colors shown may vary due to the printing process.

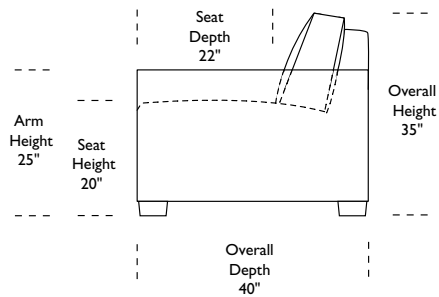

Scale: 1/4 inch = 1 foot
All dimensions are approximate and subject to change.
Specify components from the sitting position.
U.S. patents #6904628 & 8011034

V04.30.19

AMERICAN LEATHER PRODUCT CATALOG

ALL DAY SLEEPER

AMERICAN
LEATHER®

ALL DAY SLEEPER

ARTHUR



**AMERICAN
LEATHER**

AMERICAN LEATHER® ALL DAY SLEEPER

ARTHUR

Standard Features:

- Advanced unidirectional suspension system
- Premium high-density, high-resiliency foam seat cushions
- Loose back cushions
- Semi-attached seat cushions
- Single-needle top-stitch
- Lifetime warranty on frame and suspension
- 5 year foam and cover warranty
- 3 year mechanism warranty
- Quick-ship delivery

Options:

- Premium high-density, high-resiliency foam bench seat cushion
- Premium high-density, high-resiliency foam bench seat cushion with memory foam encased in down
- Premium high-density, high-resiliency foam seat cushions with memory foam encased in down
- Loose down-filled back cushions
- Low leg available with black plastic leg
- High leg available with wood leg in Acorn, Espresso and Walnut finish

Please use actual leather, fabric, Crypton®, Sunbrella® and Ultrasuede® swatches when specifying furniture as the colors shown may vary due to the printing process.

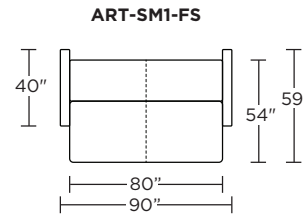
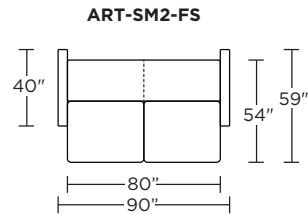
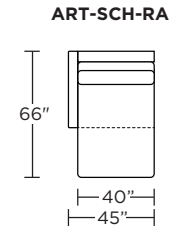
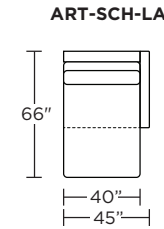
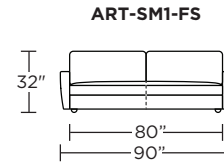
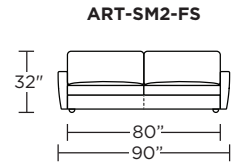
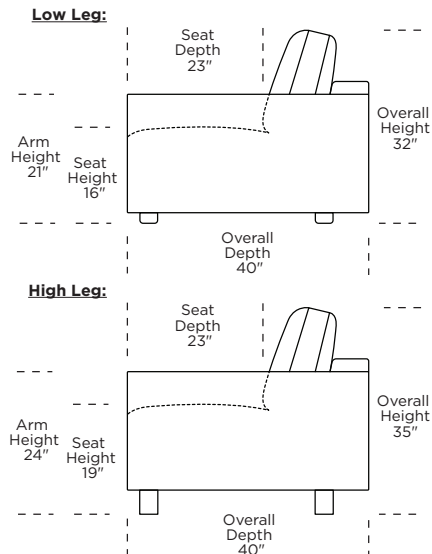

STORAGE CHAISE:

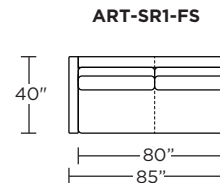
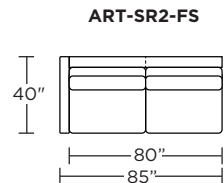
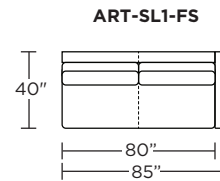
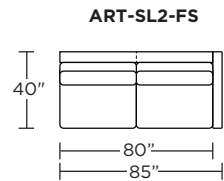
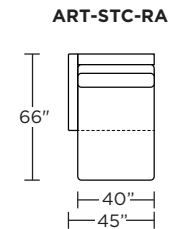
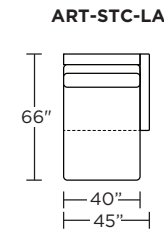

Note: Dotted line indicates seam on leather, Ultrasuede® and up the roll fabrics. Seams are eliminated with railroaded fabrics.

Scale: 1/4 inch = 1 foot
All dimensions are approximate and subject to change.
Specify components from the sitting position.

ALL DAY SLEEPER

WADE



AMERICAN
LEATHER®

AMERICAN LEATHER® ALL DAY SLEEPER

WADE

Standard Features:

- Advanced unidirectional suspension system
- Premium high-density, high-resiliency foam seat cushions
- Loose back cushions
- Semi-attached seat cushions
- Single-needle top-stitch
- Lifetime warranty on frame and suspension
- 5 year foam and cover warranty
- 3 year mechanism warranty
- Quick-ship delivery

Options:

- Premium high-density, high-resiliency foam bench seat cushion
- Premium high-density, high-resiliency foam bench seat cushion with memory foam encased in down
- Premium high-density, high-resiliency foam seat cushions with memory foam encased in down
- Loose down-filled back cushions
- Low leg available with black plastic leg
- High leg available with wood leg in Acorn, Espresso and Walnut finish

Please use actual leather, fabric, Crypton®, Sunbrella® and Ultrasuede® swatches when specifying furniture as the colors shown may vary due to the printing process.

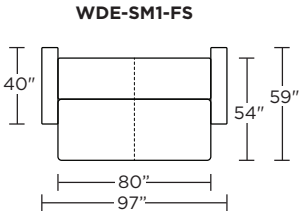
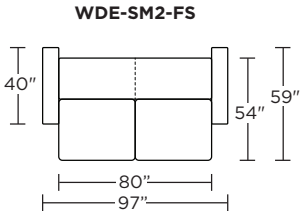
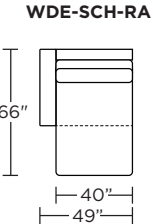
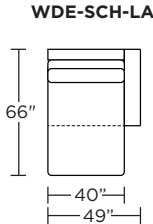
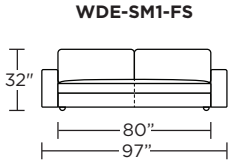
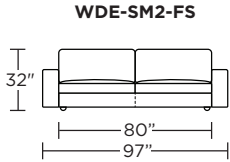
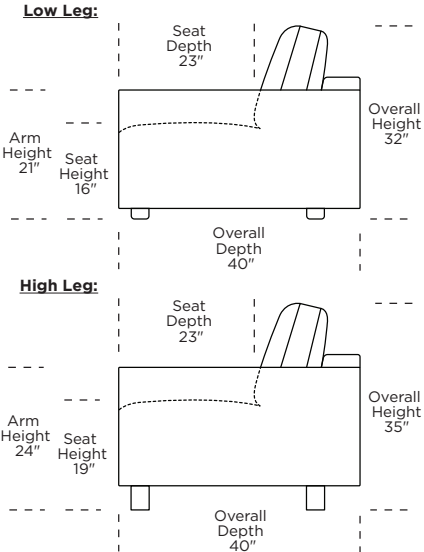

STORAGE CHAISE:

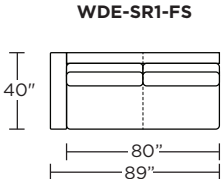
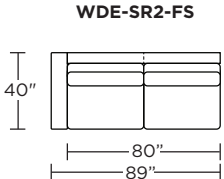
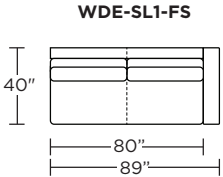
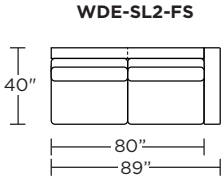
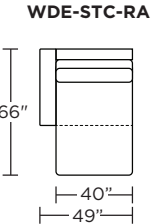
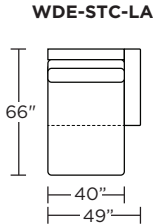

Note: Dotted line indicates seam on leather, Ultrasuede® and up the roll fabrics. Seams are eliminated with railroaded fabrics.

Scale: 1/4 inch = 1 foot
 All dimensions are approximate and subject to change.
 Specify components from the sitting position.