

# AMERICAN LEATHER PRODUCT CATALOG

---

**RE-INVENTED RECLINER®**

**AMERICAN**  
LEATHER®

# RE-INVENTED RECLINER™ COLLECTION

---

## ASTON



**AMERICAN**  
LEATHER®

**Standard Features:**

- Advanced unidirectional suspension system
- Premium high-density, high-resiliency foam seat
- Tight back and seat cushion
- Single-needle top-stitch
- Lifetime warranty on frame and suspension
- Quick-ship delivery

**Options:**

- Solid wood base available in Natural Walnut or Gray Ash

**Additional Power Options:**

- Motorized recliner with an in-seat control panel that is easy to use and includes a USB charging port
- Motor has a five-year warranty
- Lithium-ion battery pack available
- Battery pack has a one-year warranty

*Please use actual leather, fabric, Crypton®, Sunbrella® and Ultrasuede® swatches when specifying furniture as the colors shown may vary due to the printing process.*

Wall Clearance is 16"

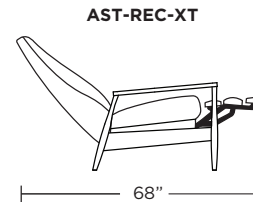
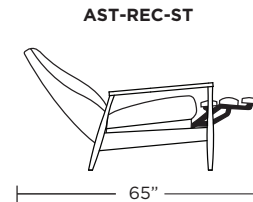
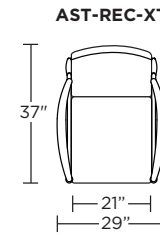
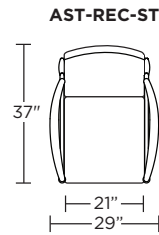
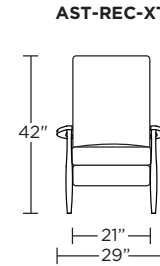
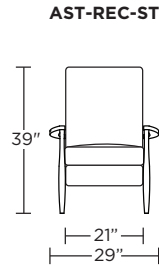
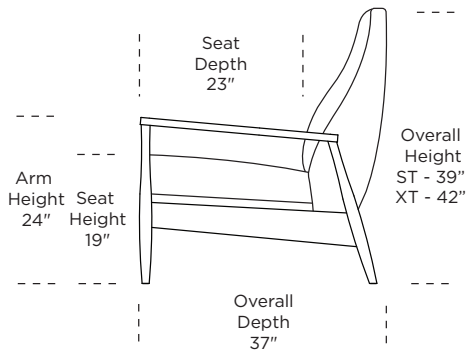

Scale: 1/4 inch = 1 foot  
All dimensions are approximate and subject to change.  
Specify components from the sitting position.

# RE-INVENTED RECLINER™ COLLECTION

---

## BLAKE



**AMERICAN**  
LEATHER®

**Standard Features:**

- Advanced unidirectional suspension system
- Premium high-density, high-resiliency foam seat
- Tight back and seat cushion
- Double-needle top-stitch
- Knife-edge detailing
- Lifetime warranty on frame and suspension
- Quick-ship delivery

**Options:**

- Swivel base available in Antique Brass, Burnished Bronze or Polished Nickel finish

**Additional Power Options:**

- Motorized recliner with an in-arm control panel that is easy to use and includes a USB charging port
- Motor has a five-year warranty
- Lithium-ion battery pack available
- Battery pack has a one-year warranty

Please use actual leather, fabric, Crypton®, Sunbrella® and Ultrasuede® swatches when specifying furniture as the colors shown may vary due to the printing process.

Wall Clearance is 16"

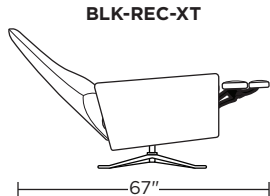
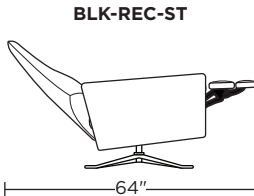
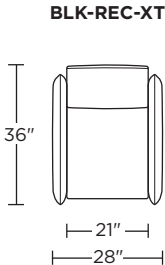
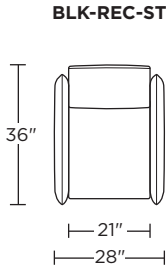
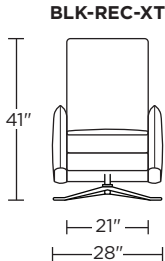
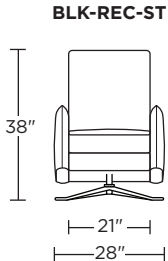
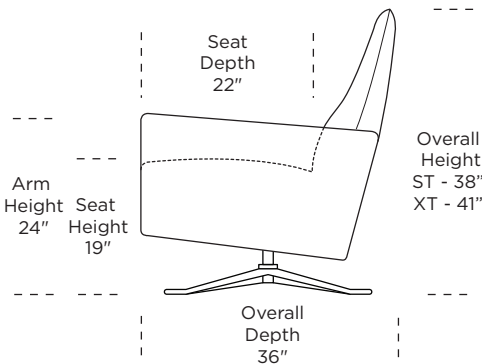

Scale: 1/4 inch = 1 foot  
All dimensions are approximate and subject to change.  
Specify components from the sitting position.

# RE-INVENTED RECLINER™ COLLECTION

---

## BURKE



**AMERICAN**  
LEATHER®

**Standard Features:**

- Advanced unidirectional suspension system
- Down blend pillow top pads on back and seat
- Premium high-density, high-resiliency foam seat
- Semi-attached back and seat cushion
- Single-needle top-stitch
- Lifetime warranty on frame and suspension
- Quick-ship delivery

**Options:**

- Premium high-density, high-resiliency foam pillow top pads on back and seat
- Solid wood legs available in Natural Walnut or Gray Ash
- Metal legs available in Antique Brass, Burnished Bronze or Polished Nickel

**Additional Power Options:**

- Motorized recliner with an in-arm control panel that is easy to use and includes a USB charging port
- Motor has a five-year warranty
- Lithium-ion battery pack available
- Battery pack has a one-year warranty

Please use actual leather, fabric, Crypton®, Sunbrella® and Ultrasuede® swatches when specifying furniture as the colors shown may vary due to the printing process.

Wall Clearance is 16"

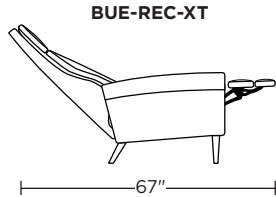
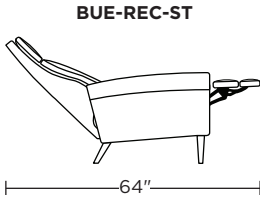
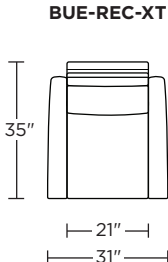
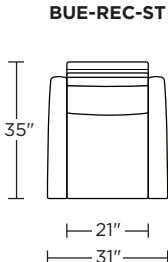
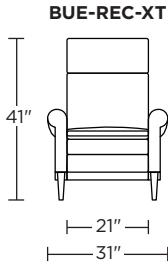
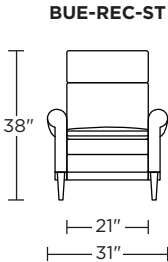
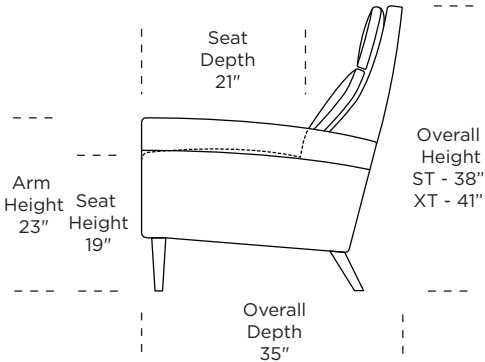

Scale: 1/4 inch = 1 foot  
All dimensions are approximate and subject to change.  
Specify components from the sitting position.

# RE-INVENTED RECLINER™ COLLECTION

---

## CALLUM



**AMERICAN  
LEATHER®**



**Standard Features:**

- Advanced unidirectional suspension system
- Premium high-density, high-resiliency foam seat
- Tight back and seat cushion
- Double-needle quilting combined with single-needle top-stitch with thick thread
- Lifetime warranty on frame and suspension
- Quick-ship delivery

**Options:**

- Wood arms in Dark Brown Ash or Natural Walnut

**Additional Power Options:**

- Motorized recliner with an on-seat control panel that is easy to use and includes a USB charging port
- Motor has a five-year warranty
- Lithium-ion battery pack available
- Battery pack has a one-year warranty

*Please use actual leather, fabric, Crypton®, Sunbrella® and Ultrasuede® swatches when specifying furniture as the colors shown may vary due to the printing process.*

Wall Clearance is 16"

CMU-REC-ST

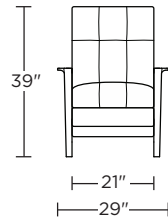

CMU-REC-XT

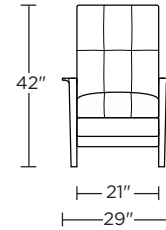

CMU-REC-ST

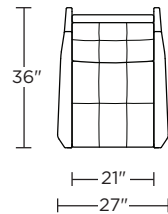

CMU-REC-XT

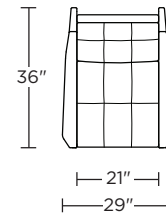

CMU-REC-ST

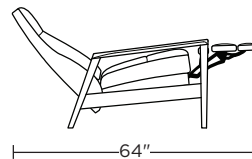

CMU-REC-XT

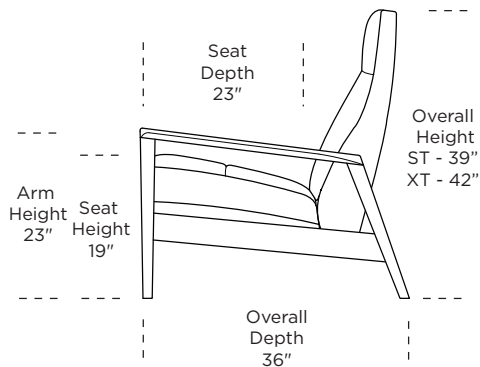
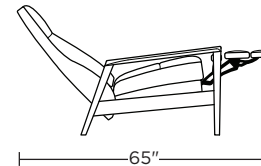

Scale: 1/4 inch = 1 foot  
All dimensions are approximate and subject to change.  
Specify components from the sitting position.

# RE-INVENTED RECLINER™

---

## ELTON



**AMERICAN**  
LEATHER®

**Standard Features:**

- Advanced unidirectional suspension system
- Down blend pillow top pad on back
- Premium high-density, high-resiliency foam seat encased in down
- Semi-attached back cushion
- Tight seat cushion
- Channel detail on back and seat cushion
- Single-needle top-stitch
- Lifetime warranty on frame and suspension
- Quick-ship delivery

**Options:**

- Premium high-density, high-resiliency foam pillow top pad on back
- Premium high-density, high-resiliency foam seat
- Wood arms available in Dark Brown Ash or Natural Walnut

**Additional Power Options:**

- Motorized recliner with an on-seat control panel that is easy to use and includes a USB charging port
- Motor has a five-year warranty
- Lithium-ion battery pack available
- Battery pack has a one-year warranty

Please use actual leather, fabric, Crypton®, Sunbrella® and Ultrasuede® swatches when specifying furniture as the colors shown may vary due to the printing process.

Wall Clearance is 16"

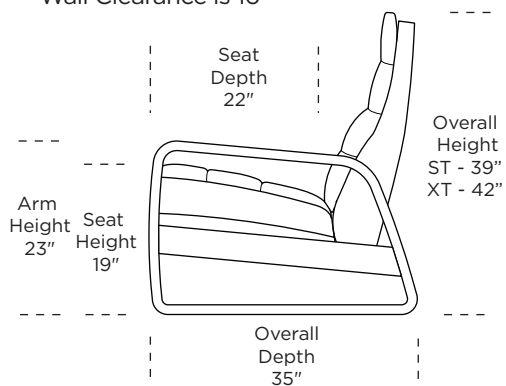

EON-REC-ST

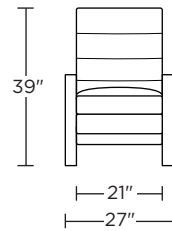

EON-REC-XT

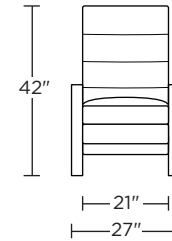

EON-REC-ST

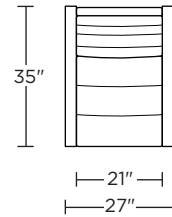

EON-REC-XT

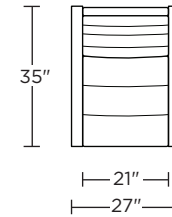

EON-REC-ST

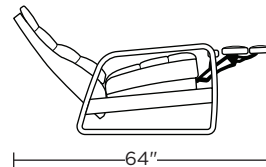

EON-REC-XT

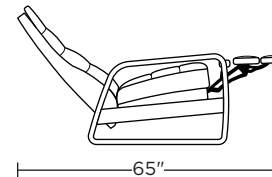

Scale: 1/4 inch = 1 foot  
All dimensions are approximate and subject to change.  
Specify components from the sitting position.

# RE-INVENTED RECLINER™ COLLECTION

---

## ISLA



**AMERICAN  
LEATHER**

**Standard Features:**

- Advanced unidirectional suspension system
- Down blend pillow top pad on back
- Premium high-density, high-resiliency foam seat
- Tight seat cushion
- Single-needle top-stitch
- Lifetime warranty on frame and suspension
- Quick-ship delivery

**Options:**

- Premium high-density, high-resiliency foam pillow top pad on back
- Metal base available in Antique Brass, Burnished Bronze or Polished Nickel

**Additional Power Options:**

- Motorized recliner with an in-arm control panel that is easy to use and includes a USB charging port
- Motor has a five-year warranty
- Lithium-ion battery pack available
- Battery pack has a one-year warranty

*Please use actual leather, fabric, Crypton®, Sunbrella® and Ultrasuede® swatches when specifying furniture as the colors shown may vary due to the printing process.*

Wall Clearance is 16"

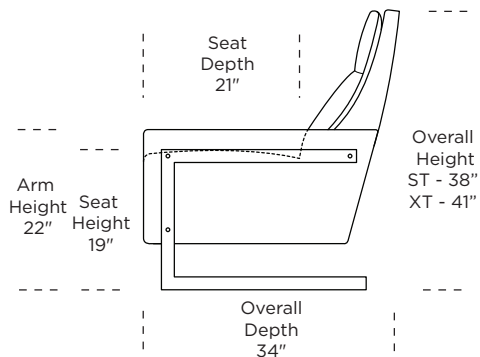
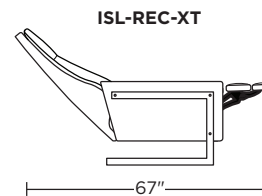
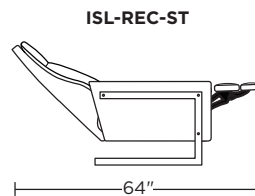
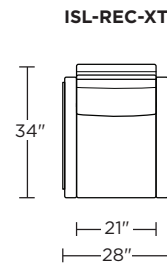
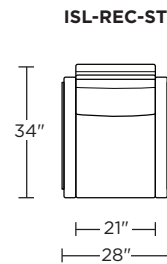
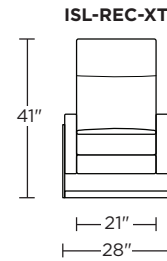
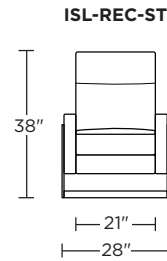

Scale: 1/4 inch = 1 foot  
All dimensions are approximate and subject to change.  
Specify components from the sitting position.

# RE-INVENTED RECLINER™ COLLECTION

---

**LEIA**



**AMERICAN  
LEATHER®**

**LEIA BY NOAH PACKARD**

**Standard Features:**

- Advanced unidirectional suspension system
- Premium high-density, high-resiliency foam seat cushion
- Tight back and seat cushion
- Double-needle top-stitch
- Lumbar pillow
- Lifetime warranty on frame and suspension
- Quick-ship delivery

**Options:**

- Contrasting lumbar pillow available
- Swivel base available in Antique Brass, Burnished Bronze, or Polished Nickel

**Additional Power Options:**

- Motorized recliner with an in-arm control panel that is easy to use and includes a USB charging port
- Motor has a five-year warranty
- Lithium-ion battery pack available
- Battery pack has a one-year warranty

*Please use actual leather, fabric, Crypton®, Sunbrella® and Ultrasuede® swatches when specifying furniture as the colors shown may vary due to the printing process.*

**Wall Clearance is 16"**

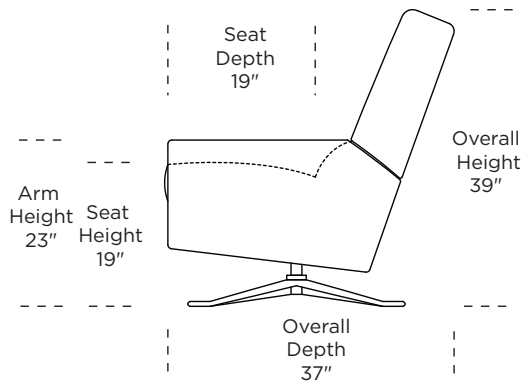

**LEA-REC-ST**

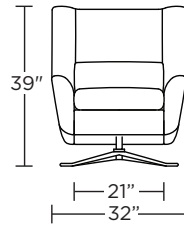

**LEA-REC-ST**

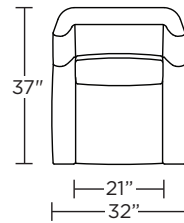

**LEA-REC-ST**

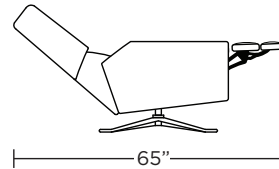

Scale: 1/4 inch = 1 foot  
All dimensions are approximate and subject to change.  
Specify components from the sitting position.

# RE-INVENTED RECLINER™ COLLECTION

---

## NEESON



**AMERICAN**  
LEATHER®



**Standard Features:**

- Advanced unidirectional suspension system
- Premium high-density, high-resiliency foam seat cushion
- Tight back and seat cushion
- Single-needle top-stitch
- Lifetime warranty on frame and suspension
- Quick-ship delivery

**Options:**

- Metal base available in Antique Brass, Burnished Bronze, or Polished Nickel

*Please use actual leather, fabric, Crypton®, Sunbrella® and Ultrasuede® swatches when specifying furniture as the colors shown may vary due to the printing process.*

**Wall Clearance is 16"**

NEE-REC-ST

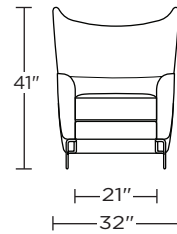

NEE-REC-ST

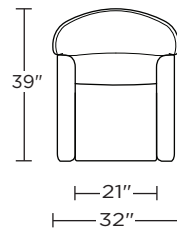

NEE-REC-ST

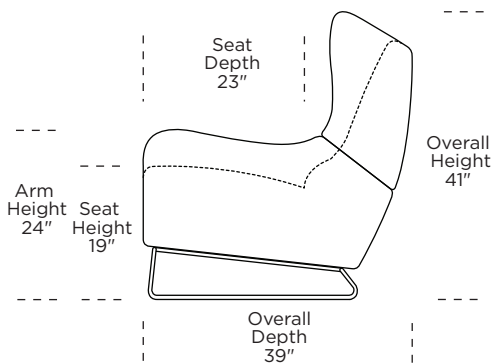
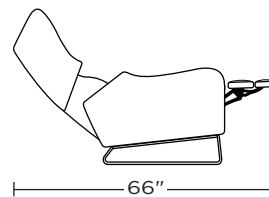

Scale: 1/4 inch = 1 foot  
All dimensions are approximate and subject to change.  
Specify components from the sitting position.

# RE-INVENTED RECLINER™ COLLECTION

---

## NICO



**AMERICAN**  
LEATHER®

**Standard Features:**

- Advanced unidirectional suspension system
- Premium high-density, high-resiliency foam seat
- Tight back and seat cushion
- Single-needle top-stitch
- Lifetime warranty on frame and suspension
- Quick-ship delivery

**Options:**

- Sled legs available in Antique Brass, Burnished Bronze or Polished Nickel

**Additional Power Options:**

- Motorized recliner with an in-arm control panel that is easy to use and includes a USB charging port
- Motor has a five-year warranty
- Lithium-ion battery pack available
- Battery pack has a one-year warranty

*Please use actual leather, fabric, Crypton®, Sunbrella® and Ultrasuede® swatches when specifying furniture as the colors shown may vary due to the printing process.*

Wall Clearance is 16"

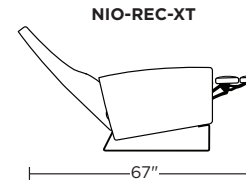
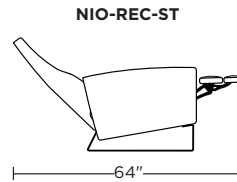
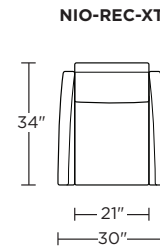
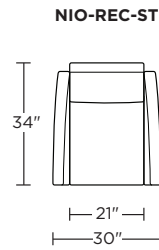
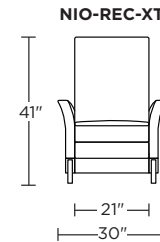
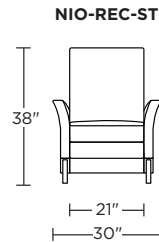
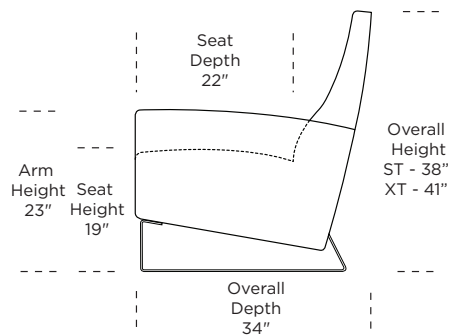

Scale: 1/4 inch = 1 foot  
All dimensions are approximate and subject to change.  
Specify components from the sitting position.

# RE-INVENTED RECLINER™ COLLECTION

---

## QUINTON



**AMERICAN**  
LEATHER®

**Standard Features:**

- Advanced unidirectional suspension system
- Premium high-density, high-resiliency foam seat
- Tight back and seat cushion
- Single-needle top-stitch
- Lifetime warranty on frame and suspension
- Quick-ship delivery

**Options:**

- Solid wood legs available in Natural Walnut or Gray Ash

**Additional Power Options:**

- Motorized recliner with an in-arm control panel that is easy to use and includes a USB charging port
- Motor has a five-year warranty
- Lithium-ion battery pack available
- Battery pack has a one-year warranty

*Please use actual leather, fabric, Crypton®, Sunbrella® and Ultrasuede® swatches when specifying furniture as the colors shown may vary due to the printing process.*

Wall Clearance is 16"

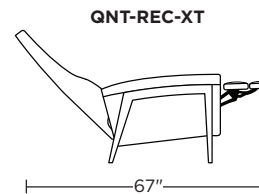
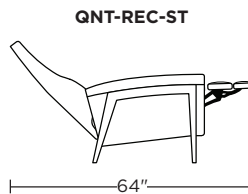
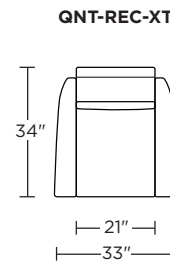
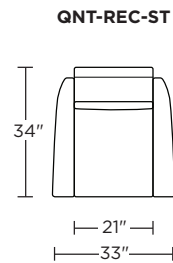
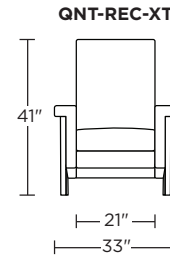
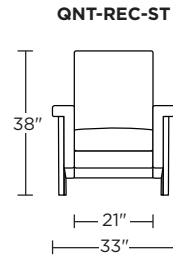
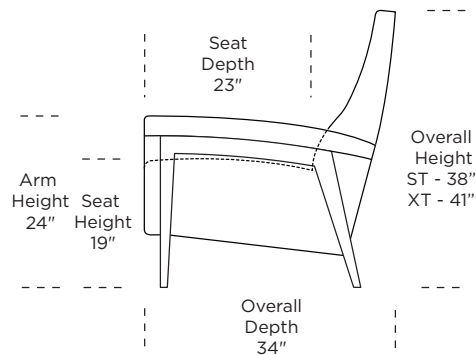

Scale: 1/4 inch = 1 foot  
All dimensions are approximate and subject to change.  
Specify components from the sitting position.

# RE-INVENTED RECLINER™ COLLECTION

---

## ROMAN



**AMERICAN**  
LEATHER®

**Standard Features:**

- Advanced unidirectional suspension system
- Down blend pillow top pads on back and seat
- Premium high-density, high-resiliency foam seat
- Semi-attached back and seat cushion
- Button tufting on back cushion
- Single-needle top-stitch
- Lifetime warranty on frame and suspension
- Quick-ship delivery

**Options:**

- Premium high-density, high-resiliency foam pillow top pads on back and seat
- Swivel base available in Antique Brass, Burnished Bronze or Polished Nickel finish

**Additional Power Options:**

- Motorized recliner with an in-arm control panel that is easy to use and includes a USB charging port
- Motor has a five-year warranty
- Lithium-ion battery pack available
- Battery pack has a one-year warranty

*Please use actual leather, fabric, Crypton®, Sunbrella® and Ultrasuede® swatches when specifying furniture as the colors shown may vary due to the printing process.*

Wall Clearance is 16"

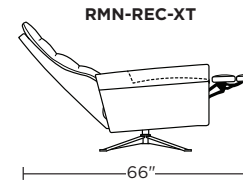
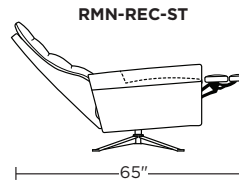
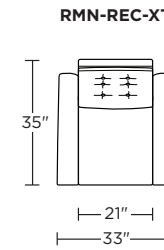
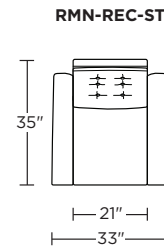
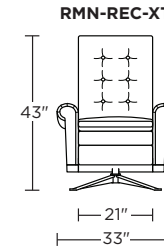
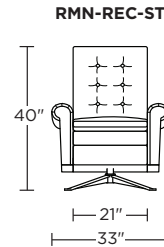
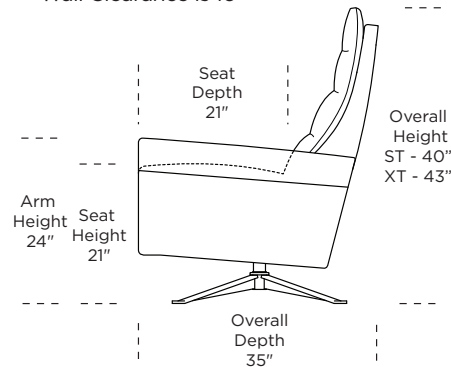

Scale: 1/4 inch = 1 foot  
All dimensions are approximate and subject to change.  
Specify components from the sitting position.

# RE-INVENTED RECLINER™ COLLECTION

---

## SIMON



**AMERICAN**  
LEATHER®



**Standard Features:**

- Advanced unidirectional suspension system
- Down blend pillow top pads on back and seat
- Premium high-density, high-resiliency foam seat
- Semi-attached back and seat cushion
- Single-needle top-stitch
- Lifetime warranty on frame and suspension
- Quick-ship delivery

**Options:**

- Premium high-density, high-resiliency foam pillow top pads on back and seat
- Swivel base available in Antique Brass, Burnished Bronze or Polished Nickel finish

**Additional Power Options:**

- Motorized recliner with an in-arm control panel that is easy to use and includes a USB charging port
- Motor has a five-year warranty
- Lithium-ion battery pack available
- Battery pack has a one-year warranty

*Please use actual leather, fabric, Crypton®, Sunbrella® and Ultrasuede® swatches when specifying furniture as the colors shown may vary due to the printing process.*

Wall Clearance is 16"

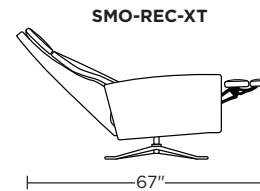
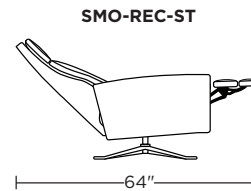
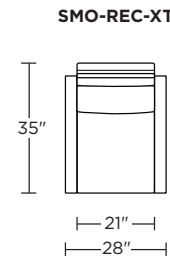
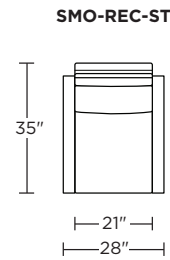
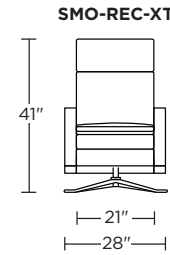
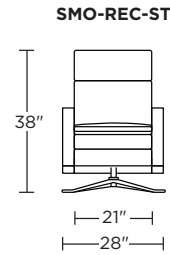
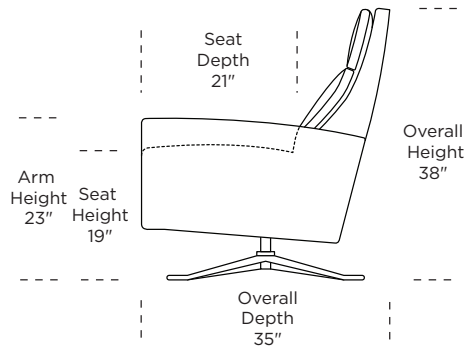

Scale: 1/4 inch = 1 foot  
All dimensions are approximate and subject to change.  
Specify components from the sitting position.

# RE-INVENTED RECLINER™ COLLECTION

---

## VIDA



**AMERICAN**  
LEATHER®

**Standard Features:**

- Advanced unidirectional suspension system
- Premium high-density, high-resiliency foam seat
- Tight back and seat cushion
- Single-needle top-stitch
- Lifetime warranty on frame and suspension
- Quick-ship delivery

**Options:**

- Solid wood legs available in Natural Walnut or Gray Ash
- Metal legs available in Antique Brass, Burnished Bronze or Polished Nickel

**Additional Power Options:**

- Motorized recliner with an in-arm control panel that is easy to use and includes a USB charging port
- Motor has a five-year warranty
- Lithium-ion battery pack available
- Battery pack has a one-year warranty

*Please use actual leather, fabric, Crypton®, Sunbrella® and Ultrasuede® swatches when specifying furniture as the colors shown may vary due to the printing process.*

Wall Clearance is 16"

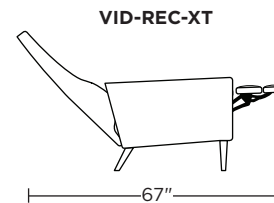
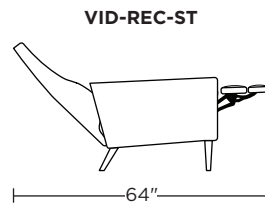
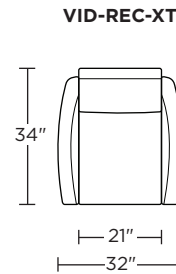
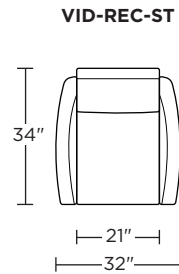
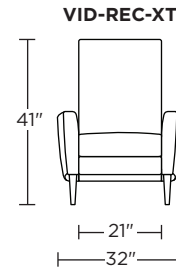
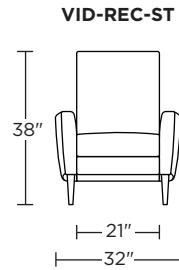
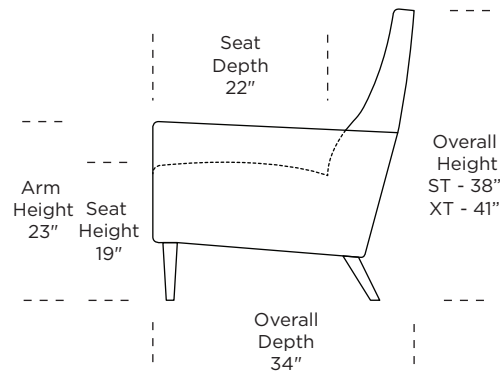

Scale: 1/4 inch = 1 foot  
All dimensions are approximate and subject to change.  
Specify components from the sitting position.