

AMERICAN LEATHER PRODUCT CATALOG

ALL DAY SLEEPER

AMERICAN
LEATHER®

ALL DAY SLEEPER

ARTHUR



**AMERICAN
LEATHER**

AMERICAN LEATHER® ALL DAY SLEEPER

ARTHUR

Standard Features:

- Advanced unidirectional suspension system
- Premium high-density, high-resiliency foam seat cushions
- Loose back cushions
- Semi-attached seat cushions
- Single-needle top-stitch
- Lifetime warranty on frame and suspension
- 5 year foam and cover warranty
- 3 year mechanism warranty
- Quick-ship delivery

Options:

- Premium high-density, high-resiliency foam bench seat cushion
- Premium high-density, high-resiliency foam bench seat cushion with memory foam encased in down
- Premium high-density, high-resiliency foam seat cushions with memory foam encased in down
- Loose down-filled back cushions
- Low leg available with black plastic leg
- High leg available with wood leg in Acorn, Espresso and Walnut finish

Please use actual leather, fabric, Crypton®, Sunbrella® and Ultrasuede® swatches when specifying furniture as the colors shown may vary due to the printing process.

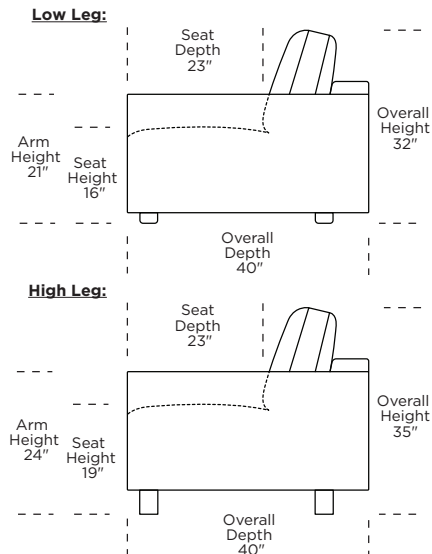

Note: Dotted line indicates seam on leather, Ultrasuede® and up the roll fabrics. Seams are eliminated with railroaded fabrics.

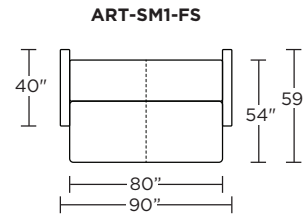
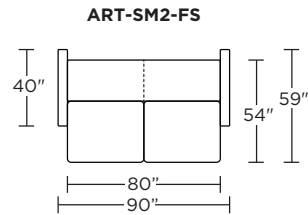
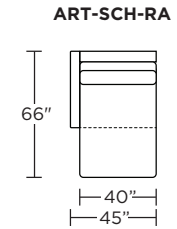
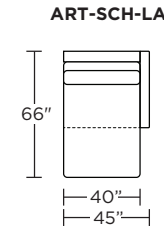
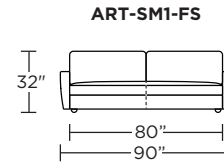
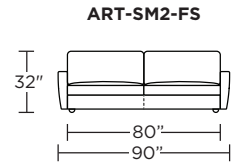

STORAGE CHAISE:

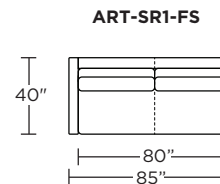
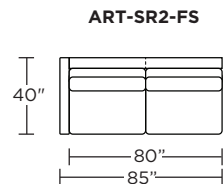
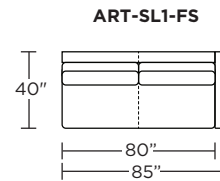
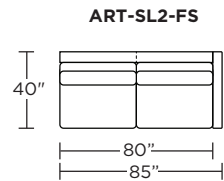
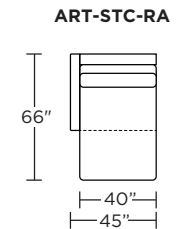
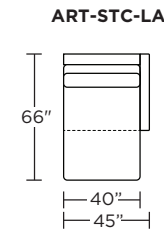

V.06.22.21

Scale: 1/4 inch = 1 foot
All dimensions are approximate and subject to change.
Specify components from the sitting position.

ALL DAY SLEEPER

WADE



**AMERICAN
LEATHER®**

AMERICAN LEATHER® ALL DAY SLEEPER

WADE

Standard Features:

- Advanced unidirectional suspension system
- Premium high-density, high-resiliency foam seat cushions
- Loose back cushions
- Semi-attached seat cushions
- Single-needle top-stitch
- Lifetime warranty on frame and suspension
- 5 year foam and cover warranty
- 3 year mechanism warranty
- Quick-ship delivery

Options:

- Premium high-density, high-resiliency foam bench seat cushion
- Premium high-density, high-resiliency foam bench seat cushion with memory foam encased in down
- Premium high-density, high-resiliency foam seat cushions with memory foam encased in down
- Loose down-filled back cushions
- Low leg available with black plastic leg
- High leg available with wood leg in Acorn, Espresso and Walnut finish

Please use actual leather, fabric, Crypton®, Sunbrella® and Ultrasuede® swatches when specifying furniture as the colors shown may vary due to the printing process.

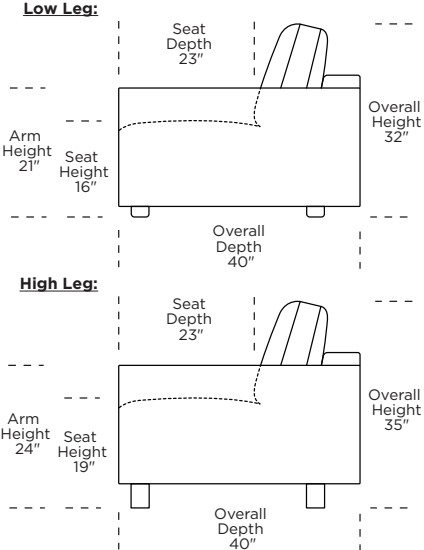

Note: Dotted line indicates seam on leather, Ultrasuede® and up the roll fabrics. Seams are eliminated with railroaded fabrics.

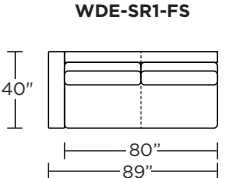
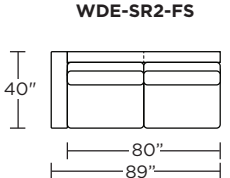
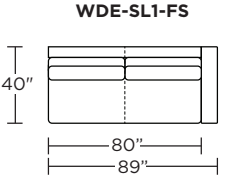
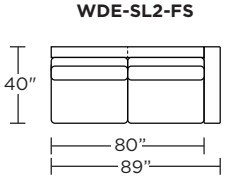
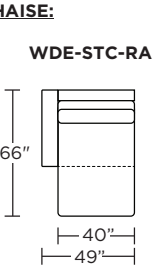
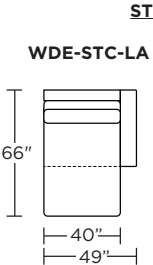
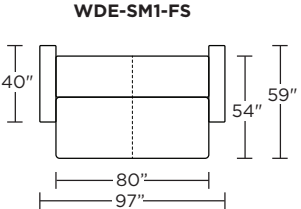
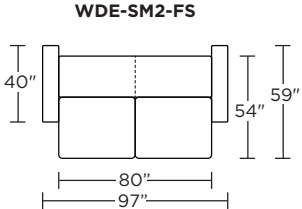
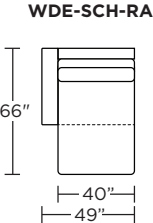
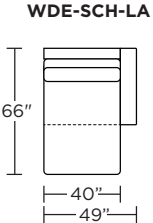
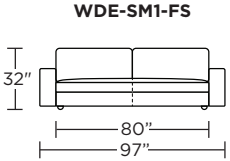
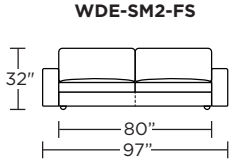

STORAGE CHAISE:

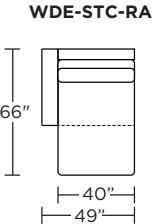
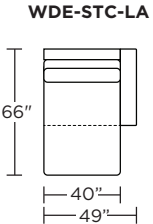

V.06.22.21

Scale: 1/4 inch = 1 foot
All dimensions are approximate and subject to change.
Specify components from the sitting position.