



**STYLE IN
MOTION**
BY AMERICAN LEATHER

**YOUR GUIDE TO OPERATING THE
ULTIMATE IN POWER MOTION SEATING**

AMERICANLEATHER.COM

Congratulations on your purchase of a power Style in Motion® product by American Leather®.

Following are helpful hints and important safety information regarding the use and care of your Style in Motion® product.

***This product is intended for household/
residential use only.***

IMPORTANT SAFETY INSTRUCTIONS

Read all instructions before using the power Style in Motion® system. When using an electrical appliance, basic precautions should always be followed, including the following:

DANGER! To Reduce the Risk of Electric Shock:

Always unplug the power Style in Motion® product from the electrical outlet before cleaning.

WARNING! Risk of Injury:

Keep children away from the extended foot support and any moving parts.

CAUTION! Do not allow children to play on the power Style in Motion® product or operate the power Style in Motion® mechanism. The leg rest pulls in when closing and could possibly cause injury to a child. Always leave the power Style in Motion® product in an upright and closed position when not in use. Keep hands and feet clear of mechanism. Only the occupant should operate it.

Safety or Recall Notices:

Register your Style in Motion® warranty at americanleather.com. This will ensure that American Leather® can contact you in the event of a safety notice or product recall. Please contact your American Leather® retailer if you did not receive warranty registration information with your power Style in Motion® purchase.

POWER CORD SAFETY

WARNING!

UNPLUG AND REMOVE THE POWER CORD FROM THE WALL AND THE POWER PORT AT THE REAR OF THE POWER STYLE IN MOTION® PRODUCT WHEN NOT IN USE AND STORE THE CORD OUT OF REACH OF CHILDREN.

Fig1

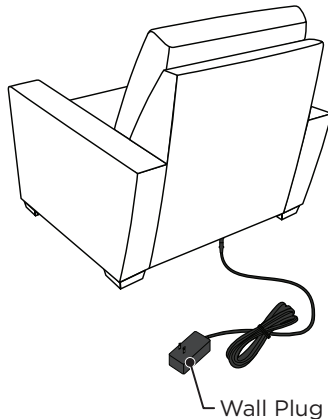

Take care when moving any power Style in Motion® product to ensure the power cord is not under the legs or the cord may get damaged.

Never operate a power Style in Motion® product if it has a damaged cord or plug.

IMPORTANT SAFETY INSTRUCTIONS

Footrest Entrapment

In the Event of an Obstruction:

- Immediately stop the power Style in Motion® product.
- Carefully open the power Style in Motion® product and free the obstruction.

WARNING!

To Reduce the Risk of Burns, Fire, Electric Shock,
or Injury to Persons:

- Use the power Style in Motion® product only for its intended use as described in this manual.
- Only operate the power Style in Motion® product when seated.
- Never press or activate the control switch if you are not actually sitting in the power Style in Motion® product.
- Only the occupant should activate the control switch.
- Operation is designed for one person only.
- Never operate the power Style in Motion® product with more than one person sitting on an individual seat.
- Never sit or stand on the footrest, or headrest.
- Each power Style in Motion® seat can accommodate an occupant of up to 300 pounds maximum.
- Do not race, play with, or abuse the power Style in Motion® mechanism.

-
- Never operate a power Style in Motion® product if it has a damaged cord or plug, if it is not working properly, if it has been dropped or damaged, or dropped into water.
 - Contact your local retailer for examination and repair.
 - To unplug the power, return the power Style in Motion® product to an upright and closed position and then remove plug from the wall outlet or power port at the rear of the power Style in Motion® product.
 - Unplug from outlet before putting on or taking off parts.
 - Close supervision is necessary when a power Style in Motion® product is used by or near children or disabled persons.
 - Keep cord away from heated surfaces.
 - Never drop or insert any object into any opening.
 - Do not use outdoors.
 - Do not operate where aerosol (spray) products are being used or where oxygen is being administered.

IMPORTANT SAFETY INSTRUCTIONS

POWER SUPPLY

Voltage in: 100-120V – 50/60 Hz Line in: 1.6A

Voltage out: 29Vdc Line out: 2A

Duty Cycle 2 min ON/ 8 min OFF

Class 2 Power Supply

Servicing of Double-Insulated Products:

All power Style in Motion® products are double-insulated products. In a double-insulated product, two systems of insulation are provided instead of grounding. No grounding means is provided on a double-insulated product, nor is a means for grounding to be added to the product.

Servicing a double-insulated product requires extreme care and knowledge of the system, and is to be done only by qualified service personnel. Replacement parts for a double-insulated product must be identical to the parts they replace. A double-insulated product is marked with the words “DOUBLE INSULATION” or “DOUBLE INSULATED.” The symbol (square within a square ) is also able to be marked on the product.

BATTERY SAFETY (optional)

If battery operation was purchased as an optional accessory to your power Style in Motion® product there are additional safety instructions to be followed.

DANGER! Risk of Physical Injury:

Power Style in Motion® products have a control box located remotely from the battery that must be secured before servicing. (See Fig. 2)

WARNING!

Unplug and remove power cord from the wall and from the power port at the rear of the power Style in Motion® product when not in use and store out of reach of children. Also, unplug the battery (See Fig. 2 on next page) to prevent use when the optional battery is mounted in the Style in Motion® power system.

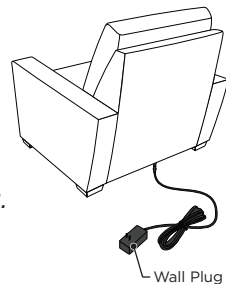

Fig 1

WARNING!

Only use an identical replacement battery supplied by your local American Leather® retailer. The battery is matched to the charging system in all power Style in Motion® products. Use of a non-identical battery could cause risk of burns, fire, electric shock, or injury to persons.

Replacement batteries can be ordered from your local American Leather® retailer.

- **Do not** use a non-rechargeable battery
- **Do not** mix old and new batteries
- **Do not** mix non-rechargeable and rechargeable batteries
- Use only one battery - **Do not** chain batteries together

USER MAINTENANCE INSTRUCTIONS

Unplug the outlet cord before cleaning a power Style in Motion® product.

If the power Style in Motion® product is equipped with an optional battery, also unplug the power cord

between the battery and the control box before cleaning or performing maintenance. (See Fig. 2)

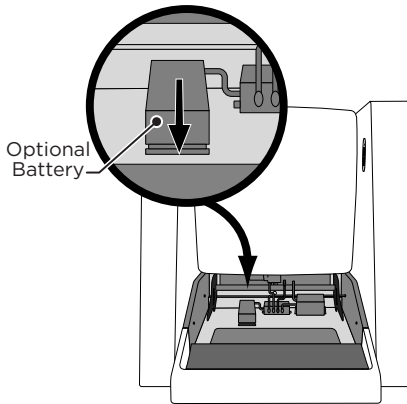

Fig2

Do not use any liquids or spray cleaners on any electrical components.

Follow the cleaning code located on the swatch label under the footrest or in your warranty booklet to clean the upholstery cover.

It is not necessary to lubricate any components of a power Style in Motion® product.

None of the electrical components are user-serviceable. Any other servicing should be performed by an authorized service representative.

If the power cables or power supply are ever damaged, replacements can be ordered from your American Leather® retailer.

OVERLOAD PROTECTION

The power Style in Motion® system has a thermal overload protection. The power supply is equipped with a thermal fuse. If the motor or power supply is overworked, this thermal fuse is tripped, which shuts off the motor and power supply. The thermal fuse will automatically reset approximately 10-15 minutes after the power supply has cooled down. The power Style in Motion® system may then be used normally.

STORAGE

If the power Style in Motion® product will not be used for an extended period of time, remove the power cord from the power port and wall outlet and store the cord out of reach of children. If the power Style in Motion® product is equipped with an optional battery, also unplug the power cord between the battery and control box. (See Fig. 2)

Store the power Style in Motion® product in a dry interior location.

SAVE THESE INSTRUCTIONS

Style in Motion[®]

by American Leather[®]

CONNECTING THE POWER SUPPLY

- Locate the power port hanging down from the rear of each powered seat. (See Fig. 1)
- Plug the power supply cord into the power port in the chair, and then plug in the wall cord.

CONTROL PANEL ATTACHED TO SEATING

Operating Control Panel:

The control buttons are backlit with LED lights that turn on automatically when a button is pressed, and will turn off automatically after four to five seconds. (See Fig. 3)

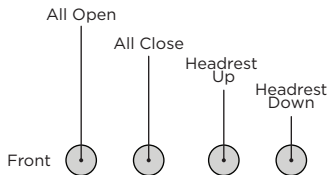
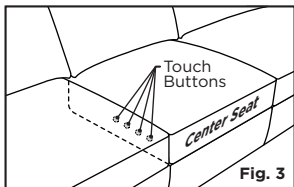
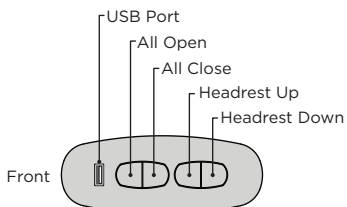
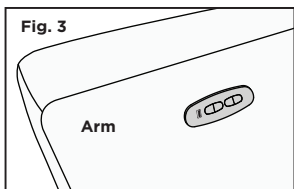

FOOTREST & BACK RECLINE

To raise the footrest and recline the back, press the **All Open** button located next to the USB port. The back rest has infinite stopping positions. Simply release the button to stop the back recline in any position. To close the footrest and restore the back to its full upright position, press the **All Close** button. (See *Fig. 3*)

ADJUSTING HEADREST

The headrest operates independently of the footrest and back recline, and has infinite stopping positions. To operate the headrest after the seat and back are in a desired position, press the **Headrest Up** button to make the headrest move forward, and press the **Headrest Down** button to make the headrest move backwards. When you have reached your desired position, simply release the button to stop the headrest in any position. When the back and footrest start closing the headrest will follow an automatic sequence to go to the fully closed position.

OPTIONAL BATTERY POWER

The purchase of the optional battery for use with a power Style in Motion® product allows it to be operated either with the cord plugged into the wall, or with battery power only. This allows you to float a power Style in Motion® product in the room without cords attached.

Battery Life:

The optional battery is a 4.0 Amp hour Lithium Ion (4.0 A/h Li-ion) battery in a fully enclosed case. The minimum life expectancy of the battery is 500 complete charge/ discharge cycles.

- * A fully charged battery will provide about 120 complete open/close cycles before it needs to be recharged.

When the battery needs charging, the power Style in Motion® product will begin to operate more slowly, indicating the battery is running out. If the battery gets to about 10% of capacity, a beeping tone will sound when any of the control buttons are pressed, indicating that the power Style in Motion® battery needs to be recharged immediately.

Please note that for optimal battery life, the battery should not be used to its capacity, or used until the power Style in Motion® product stops working. It is recommended that the battery be charged once per month if it is not going to be used for an extended period of time.

- * *Based on a fully charged battery. Cycle count will depend on users weight. Battery charge will degrade over the life of the battery. Using USB port while operating on battery is not recommended. (will reduce battery life)*

Battery Recharging:

To recharge the battery in the power Style in Motion® product, plug the cord from the power supply into the power port at the rear of the power Style in Motion® product and then plug the power supply into an electrical outlet as shown in *Fig. 1*.

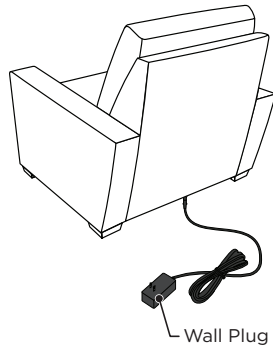

Fig1

The power system has an automatic power selector system that chooses battery power or power from the wall outlet, depending on whether the power Style in Motion® product is plugged in or not.

If the power Style in Motion® product is plugged in for recharging, the automatic power selector system will provide power to charge the battery and operate the power Style in Motion® product at the same time.

If the cord is plugged into the power Style in Motion® product continuously, the system will not overcharge the battery.

The charging time for the battery is about sixteen hours.

Battery Replacement Instructions (OPTIONAL):

Your power Style in Motion® product may be equipped with optional battery power. Follow the instructions below for any power Style in Motion® product that is equipped with this feature.

In the event that the battery needs to be replaced:

(See Fig. 5)

1. Partially open the footrest and tilt the headrest fully forward on the Style In Motion® product.
2. Unplug the power cord from the power port at the rear of the power Style in Motion® product.
3. Un-zip the back cushion assembly zipper flap and look down between the back cushion assembly and the back.
4. Locate the battery attached to the frame behind the mechanism, next to the control box.
(There is a battery for each motion seat)
5. The battery is in a charging dock and is removable by pulling the battery straight up. *(See Fig. 5)*
6. Re-install new battery into the charging dock.
7. Plug the cord back into the power port at the back of the Style In Motion® product. Then plug the other end of the power cord into the wall outlet.
8. Zip the back cushion zipper flap. The seat is now ready to use.

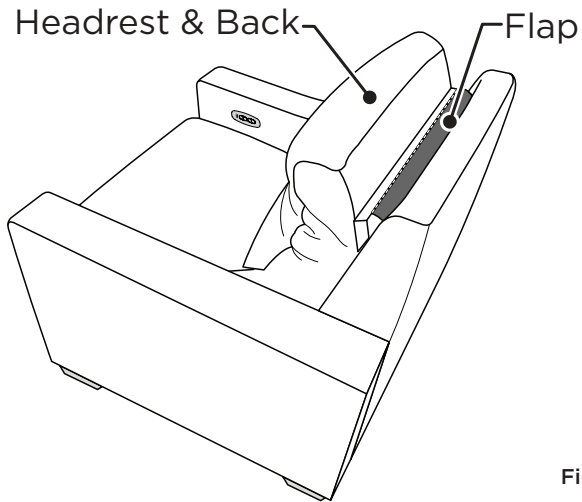
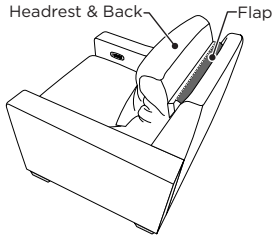

Fig 5

1. Open footrest and move the headrest all the way forward. Between flap and headrest, unzip the zipper completely. Look down into the back cavity and locate the battery. Reach down into the back cavity, grasp the battery and slide it straight up and out of its charging dock.

BACK CUSHION & BATTERY REMOVAL



1. Move headrest all of the way forward. Between flap and headrest, unzip the zipper completely. Firmly hold headrest under zipper, and pull up and towards the rear of the recliner to release back. Lay the back on the seat.

Warning: There is wire connecting headrest motor to control box. If your Style in Motion® has the optional lumbar support, there will also be an air hose attached to the back cushion. Be careful when removing back as you may damage the wire or air hose if you move the back too far before disconnecting wire and optional lumbar air hose.

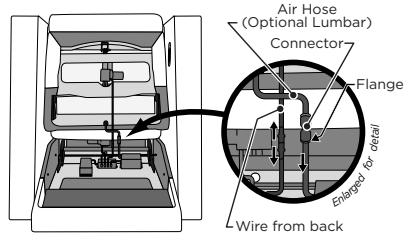

2. Follow the wire from the back and unplug it. Disconnect the air hose by pushing the flange towards the middle of the connector and hold it while pulling hose out of connector. Set the back aside.

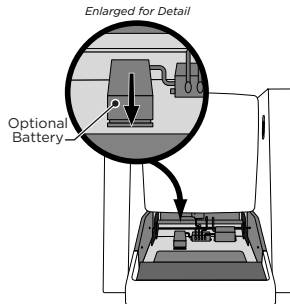

3. Grasp battery by the sides and pull straight up and out of its charging dock.

Fig 6

**DESIGNED &
DELIVERED**
TO YOUR HOME IN
30 DAYS

**AMERICAN
LEATHER**

AMERICANLEATHER.COM

(190865) V14.2021