

AMERICAN LEATHER PRODUCT CATALOG

METROPOLIS

AMERICAN
LEATHER®

SOFAS & SECTIONALS

BARCELONA



**AMERICAN
LEATHER**

AMERICAN LEATHER® SOFAS & SECTIONALS COLLECTION

BARCELONA

Standard Features:

- Advanced unidirectional suspension system
- Premium high-density, high-resiliency foam seat cushions
- Loose back and seat cushions
- Lifetime warranty on frame and suspension
- Quick-ship delivery
- Double-needle quilting combined with single-needle top-stitch with thick thread

Options:

- Contrasting stitch detail available in Black, Brown, Charcoal, Cream, Espresso, Grey, Lemon, Pink, Royal, Scarlet, Tangerine, or Teal thread color
- High leg Barcelona available with aluminum legs in Black, Bronze or Polished finish
- Low leg Barcelona available with plinth base in Black, Bronze or Polished finish

Please use actual leather, fabric, Crypton®, Sunbrella® and Ultrasuede® swatches when specifying furniture as the colors shown may vary due to the printing process.

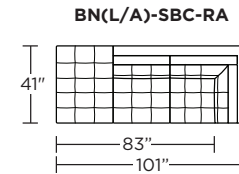
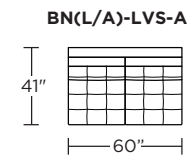
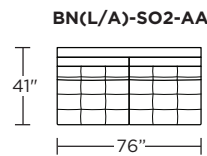
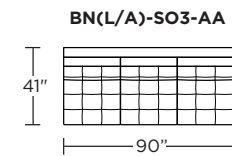
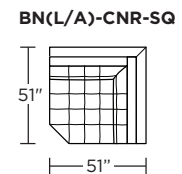
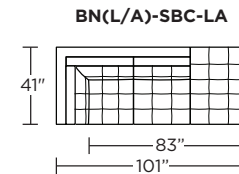
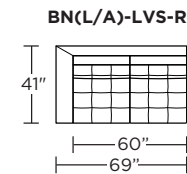
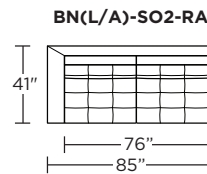
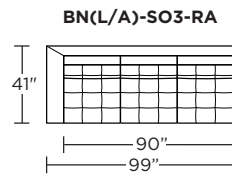
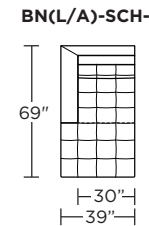
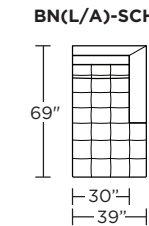
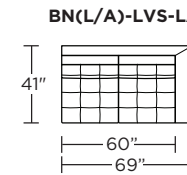
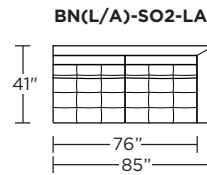
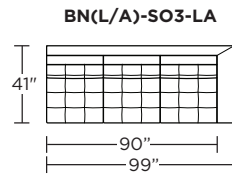
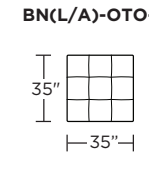
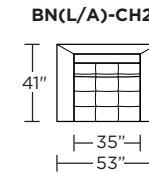
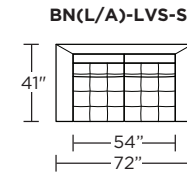
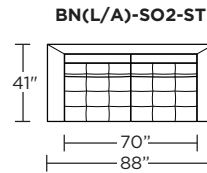
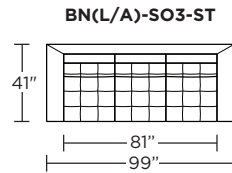

Barcelona Low Leg (BNL):

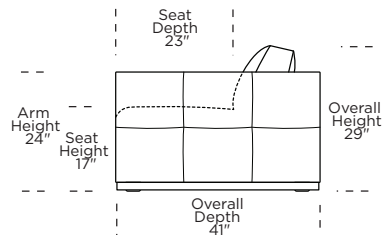

Barcelona High Leg (BNA):

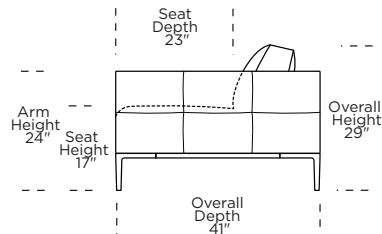

BNL = LOW LEG
BNA = HIGH LEG

Scale: 1/8 inch = 1 foot
All dimensions are approximate and subject to change.
Specify components from the sitting position.

V.04.28.21

SOFAS & SECTIONALS

COPENHAGEN



**AMERICAN
LEATHER**

AMERICAN LEATHER® SOFAS & SECTIONALS COLLECTION

COPENHAGEN

Standard Features:

- Advanced unidirectional suspension system
- Premium high-density, high-resiliency foam seat cushions
- Loose back and seat cushions
- Single-needle top-stitch
- Lifetime warranty on frame and suspension
- Quick-ship delivery

Options:

- Choice of decorative stitch detail - blanket, cross, double-needle, or zig-zag
- Contrasting stitch detail available in Black, Brown, Charcoal, Cream, Espresso, Grey, Lemon, Pink, Royal, Scarlet, Tangerine, or Teal thread color
- Aluminum legs available in Black, Bronze or Polished finish

Please use actual leather, fabric, Crypton®, Sunbrella® and Ultrasuede® swatches when specifying furniture as the colors shown may vary due to the printing process.

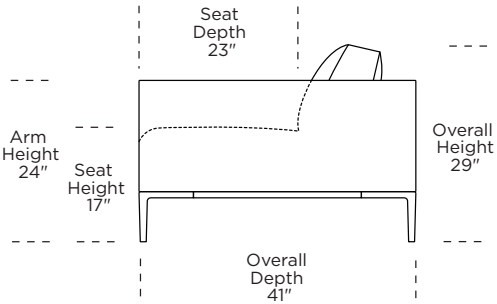
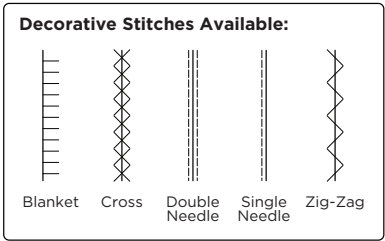

Note: Dotted line indicates seam on leather, Ultrasuede® and up the roll fabrics. Seams are eliminated with railroaded fabrics.

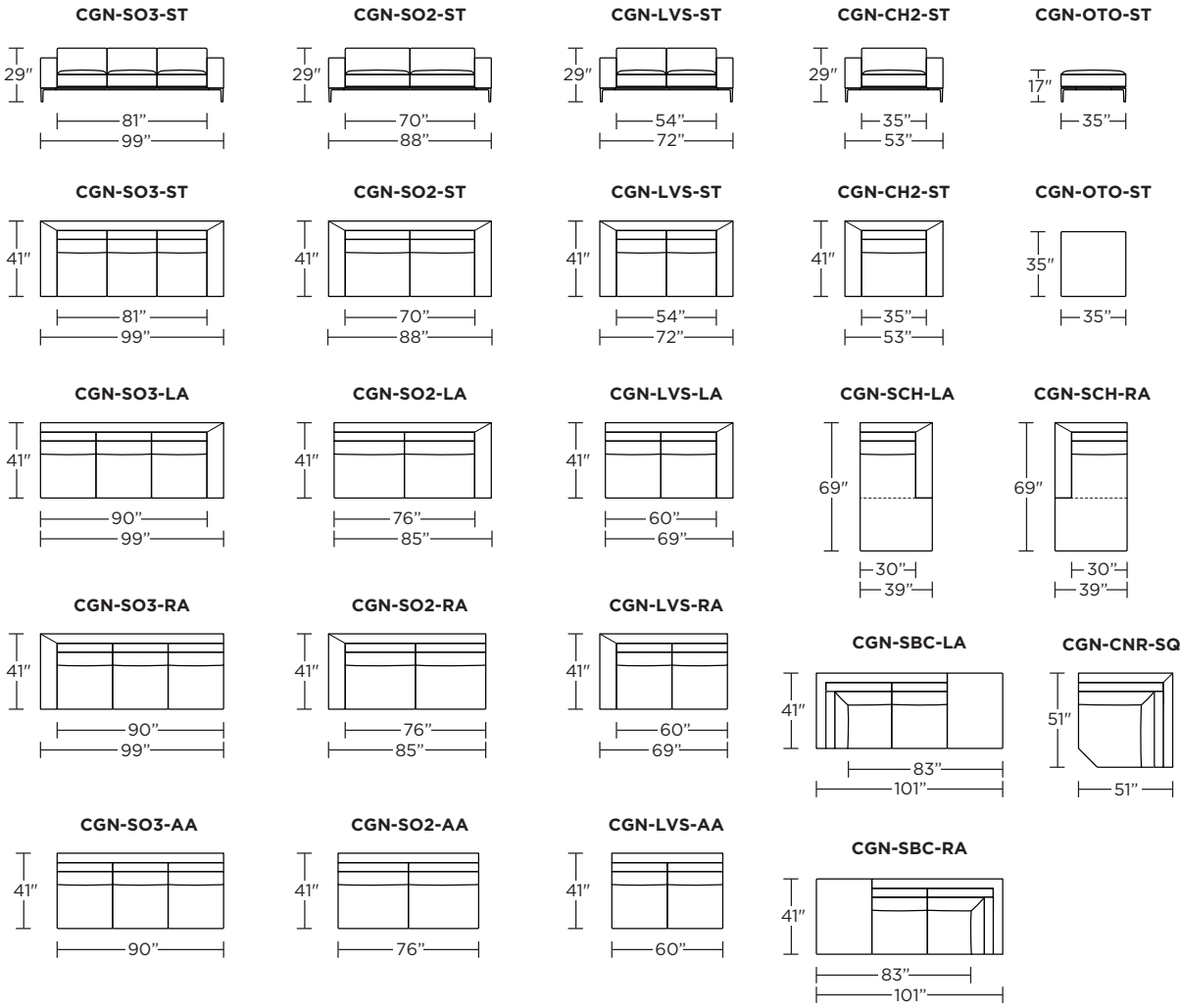

V.10.09.19

Scale: 1/8 inch = 1 foot
All dimensions are approximate and subject to change.
Specify components from the sitting position.

SOFAS & SECTIONALS

LONDON



**AMERICAN
LEATHER**

AMERICAN LEATHER® SOFAS & SECTIONALS COLLECTION

LONDON

Standard Features:

- Advanced unidirectional suspension system
- Premium high-density, high-resiliency foam seat cushions
- Loose back and seat cushions
- Single-needle top-stitch
- Lifetime warranty on frame and suspension
- Quick-ship delivery

Options:

- Choice of decorative stitch detail - blanket, cross, double-needle, or zig-zag
- Contrasting stitch detail available in Black, Brown, Charcoal, Cream, Espresso, Grey, Lemon, Pink, Royal, Scarlet, Tangerine, or Teal thread color
- High leg London available with aluminum legs in Black, Bronze or Polished finish
- Low leg London available with plinth base in Black, Bronze or Polished finish

Please use actual leather, fabric, Crypton®, Sunbrella® and Ultrasuede® swatches when specifying furniture as the colors shown may vary due to the printing process.

London Low Leg (LDL):

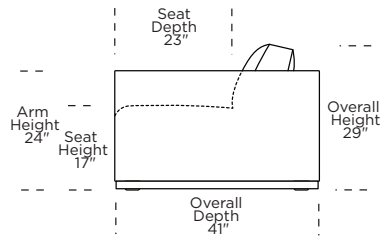

London High Leg (LDO):

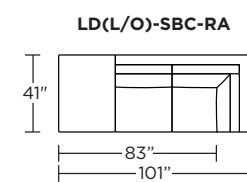
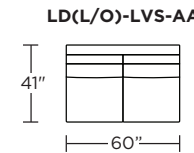
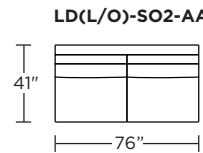
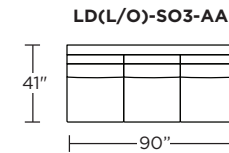
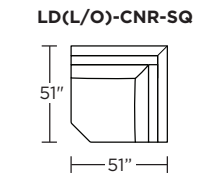
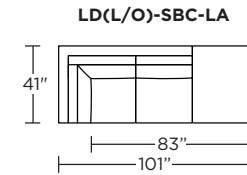
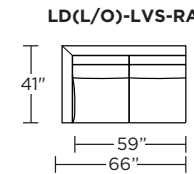
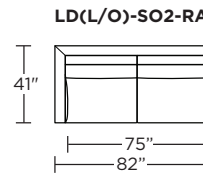
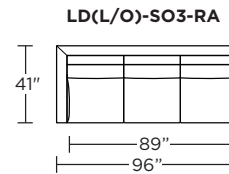
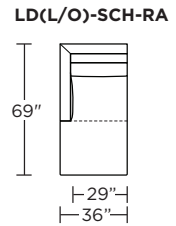
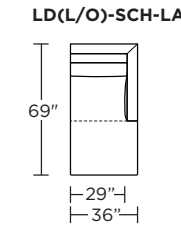
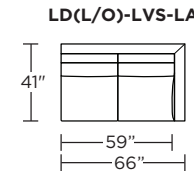
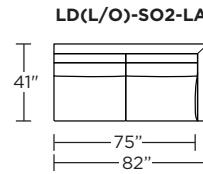
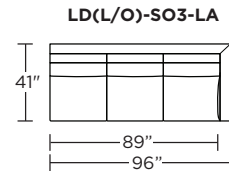
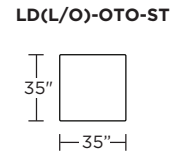
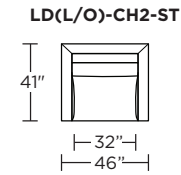
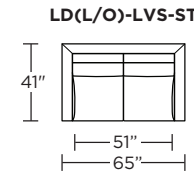
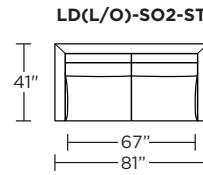
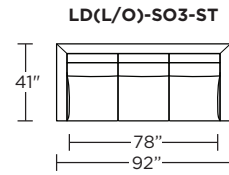
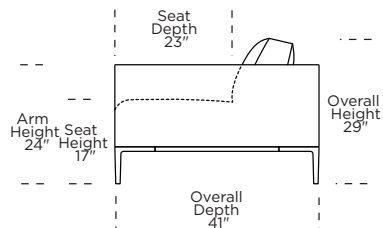

Decorative Stitches Available:

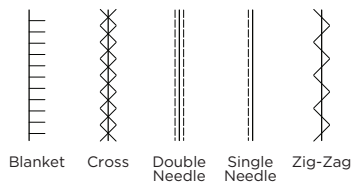

LDL = LOW LEG
LDO = HIGH LEG

Scale: 1/8 inch = 1 foot
All dimensions are approximate and subject to change.
Specify components from the sitting position.

V.10.27.21

Note: Dotted line indicates seam on leather, Ultrasuede® and up the roll fabrics. Seams are eliminated with railroaded fabrics.

SOFAS & SECTIONALS BY AMERICAN LEATHER®

MANHATTAN



**AMERICAN
LEATHER®**

AMERICAN LEATHER® SOFAS & SECTIONALS COLLECTION

MANHATTAN

Standard Features:

- Advanced unidirectional suspension system
- Premium high-density, high-resiliency foam seat cushions
- Loose back and seat cushions
- Double-needle top-stitch
- Recessed welt detail
- Lifetime warranty on frame and suspension
- Quick-ship delivery

Options:

- Contrasting welt detail available
- Contrasting stitch detail available in Black, Brown, Charcoal, Cream, Espresso, Grey, Lemon, Pink, Royal, Scarlet, Tangerine, or Teal thread color
- Aluminum legs available in Black, Bronze or Polished finish

Please use actual leather, fabric, Crypton®, Sunbrella® and Ultrasuede® swatches when specifying furniture as the colors shown may vary due to the printing process.

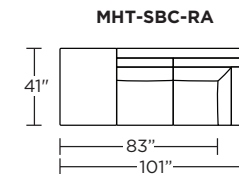
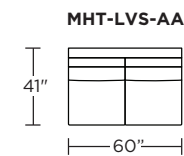
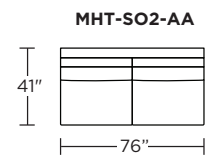
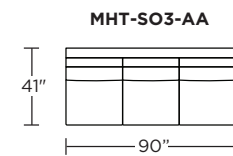
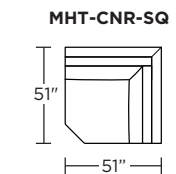
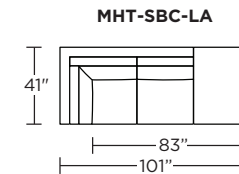
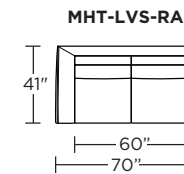
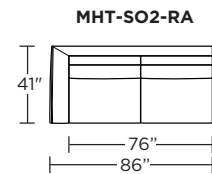
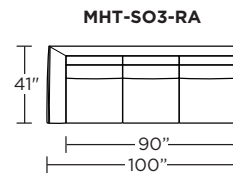
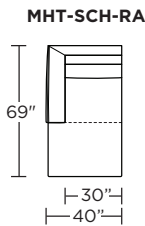
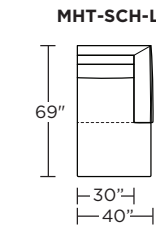
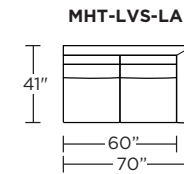
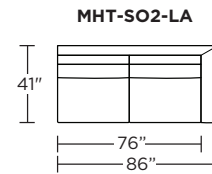
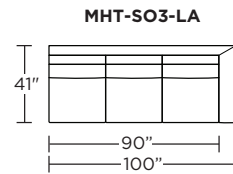
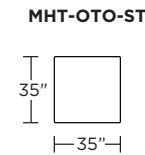
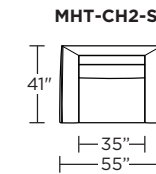
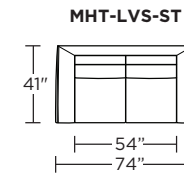
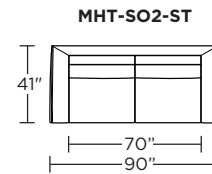
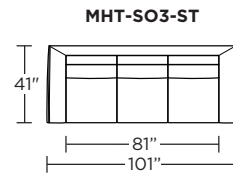
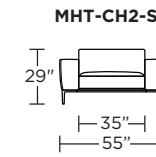
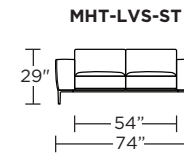
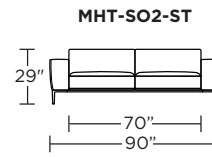
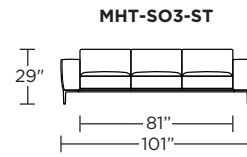
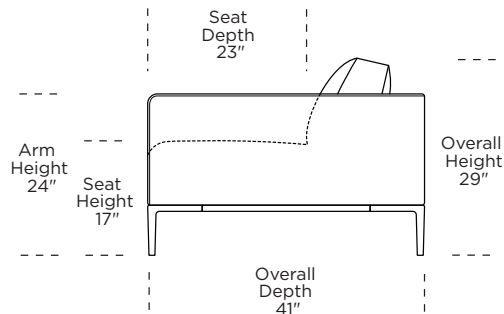

Note: Dotted line indicates seam on leather, Ultrasuede® and up the roll fabrics. Seams are eliminated with railroaded fabrics.

Scale: 1/8 inch = 1 foot
All dimensions are approximate and subject to change.
Specify components from the sitting position.

V.10.09.19